

111 4x18W

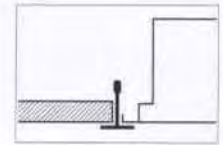
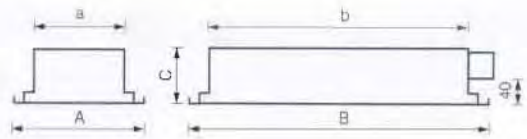

A white colour pickled steel sheet housing The longitudinal and tranverse highly polished parabolic optical grid of 99.99% aluminium allows excellent distribution of light (50...200 cd/m²). Application: banks, insurance company offices, offices with video terminals, drawing offices...

Ohišje iz dekapirane jeklene pločevine bele barve. Vzdolžni i prečni visoko sijajni parabolični raster iz 99.99% aluminija omogućava izredno porazdelitev svetlobe (50...200 cd/m²). Uporaba: banke, zavarovalnice, pisarne z video terminali, projektivni biroji...

Корпус из деканпированной листовой стали белого цвета. Продольный и поперечный блестящий параболический растр из 99.99% алюминия осуществляет особенное распределение света (50...200 нд/м²). Применение: банки, страховые агентства, офисы с видео терминалами, проектные бюро...

Kućište iz dekapiranog čeličnog lima bijele boje. Uzdužni i poprečni visoko sjajni parabolični raster iz 99.99% aluminija omogućava izvanrednu disperziju svjetlosti (50...200 cd/m²). Upotreba: banke, osiguravajući zavodi, kancelarije s video terminalima, projekt biroji...

Code	Art	W	Photo data	A	B	C	a	b	kg	dm ³	Price
11102181	111	2x18	01	297	597	100	275	575	3.5	22	
11102361	111	2x36	01	297	1197	100	275	1175	6.4	42	
11102581	111	2x58	01	297	1497	100	275	1475	9.5	52	
11103181	111	3x18	02	597	597	100	575	575	5.7	43	
11103361	111	3x36	02	597	1197	100	575	1175	11.4	83	
11104181	111	4x18	02	597	597	100	575	575	5.8	43	
11104361	111	4x36	02	597	1197	100	575	1175	12.0	83	

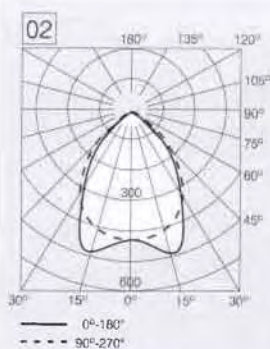

111 - 4x18			Flux CODE 81 100 100 100 67																						
Index	CIE	CIE	REFLECTIONS																						
SPACE K	DDR	RCS	873	871	773	771	753	751	731	711	551	531	511	331	000										
0.60	562	1	55	51	54	50	47	45	41	39	44	41	39	41	38										
0.80	641	-	61	56	60	55	53	50	47	45	50	47	44	46	43										
1.00	708	-	66	59	65	59	58	55	52	49	54	51	49	51	48										
1.25	765	-	70	62	67	62	63	58	56	53	57	55	53	54	52										
1.50	805	-	73	64	71	64	66	61	58	56	60	58	56	57	54										
2.00	865	-	77	67	75	66	71	64	62	61	63	62	60	61	58										
2.50	900	-	80	69	77	68	74	66	65	63	65	64	63	63	61										
3.00	924	-	81	70	79	69	76	68	66	65	66	65	64	64	62										
4.00	945	-	83	71	81	70	78	69	68	67	68	67	66	66	64										
5.00	956	-	84	71	82	71	79	70	69	68	68	68	67	67	64										
10.00	977	-	86	72	83	72	82	76	71	70	70	69	69	68	66										

531 - H(3.00-0.85)m - F1*F2=0.75			
AREA A*B	NUMBER OF LIGHTS REFLECTION		
	120 lx	250 lx	500 lx
10m ²	0.6	1.2	2.5
20m ²	1.1	2.2	4.5
30m ²	1.5	3.2	6.3
50m ²	2.4	5.0	9.9
70m ²	3.2	6.7	13.4
100m ²	4.6	9.5	19.0
150m ²	6.7	14.0	28.0



112 4x18W

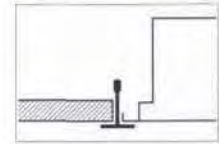
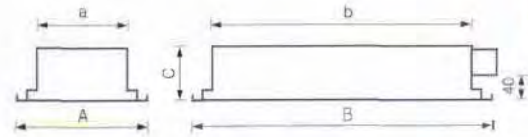

597 IP20 60°

A white colour pickled steel sheet housing. The longitudinal and transverse polished parabolic optical grid of 99.90% aluminium allows very good distribution of light (60...200 cd/m²). Application: banks, insurance company offices, offices with video terminals, shopping centres...

Ohišje iz dekapirane jeklene pločevine bele barve. Vzdolžni in prečni sijajni parabolični raster iz 99.90% aluminija omogoča zelo dobro porazdelitev svetlobe (60...200 cd/m²). Uporaba: banke, zavarovalnice, pisarne z video terminali, trgovski centri...

Корпус из декапированной листовой стали белого цвета. Продольный и поперечный подблестящий параболический raster из 99.90% алюминия осуществляет особенно хорошее распределение света (60...200 cd/m²). Применение: банки, страховые агентства, офисы с видео терминалами, торговые центры...

Kućište iz dekapiranog čeličnog lima bijele boje. Uzdužni i poprečni sjajni parabolični raster iz 99.90% aluminija omogućava vrlo dobru disperziju svjetlosti (60...200 cd/m²). Upotreba: banke, osiguravajući zavodi, kancelarije s video terminalima, trgovački centri...

Code	Art.	W	Photo data	A	B	C	a	b	kg	dm ³	Price
11202181	112	2x18	03	297	597	100	275	575	3.5	22	
11202361	112	2x36	03	297	1197	100	275	1175	6.4	42	
11202581	112	2x58	03	297	1497	100	275	1475	9.5	52	
11203181	112	3x18	04	597	597	100	575	575	5.7	43	
11203361	112	3x36	04	597	1197	100	575	1175	11.4	83	
11204181	112	4x18	04	597	597	100	575	575	5.8	43	
11204361	112	4x36	04	597	1197	100	575	1175	12.0	83	

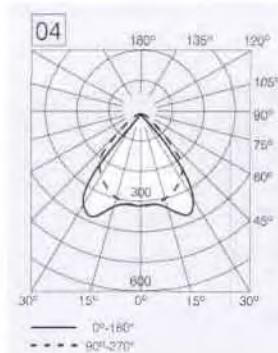

112 - 4x18				Flux CODE 87 100 100 100 87															
Index SPACE K	CIE DDR	CIE RCS	REFLECTIONS																
			873	871	773	771	753	751	731	711	551	531	511	331	000				
0.60	538	1	47	43	46	43	40	38	35	33	37	35	33	34	32				
0.80	621	1	53	48	51	47	45	43	40	38	42	40	38	39	37				
1.00	692	1	57	51	56	51	50	47	44	42	46	44	42	43	41				
1.25	752	1	61	54	58	53	54	50	48	46	49	47	46	47	44				
1.50	794	-	63	56	62	55	57	52	50	48	52	50	48	49	47				
2.00	856	-	67	58	65	58	61	56	54	52	55	53	52	53	50				
2.50	892	-	69	60	67	59	64	57	56	55	56	55	54	55	52				
3.00	917	-	71	61	69	60	66	59	58	56	58	57	56	56	54				
4.00	938	-	72	62	70	61	68	60	59	58	59	58	57	57	55				
5.00	950	-	73	62	71	61	69	61	60	59	59	59	58	58	56				
10.00	972	1	75	63	73	62	71	66	61	61	61	60	60	59	57				

531 - H(3.00-0.85)m - F1*F2=0.75			
AREA A*B	NUMBER OF LIGHTS REFLECTION		
	120 lx	250 lx	500 lx
10m ²	0.7	1.5	2.9
20m ²	1.3	2.6	5.2
30m ²	1.8	3.7	7.3
50m ²	2.7	5.7	11.5
70m ²	3.7	7.7	15.4
100m ²	5.3	11.0	21.9
150m ²	7.7	16.1	32.3



114 4x18W

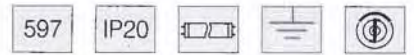
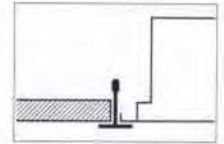
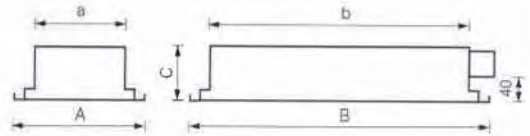

A white colour pickled steel sheet housing. The longitudinal V optical grid and fluted transverse blades of 99.85% aluminium allow good distribution of light. Application: offices, shopping centres, banks, car shows...

Ohišje iz dekapirane jeklene pločevine bele barve. Vz dolžni V raster iz 99.85% aluminija in prečne narebrane lamele omogočajo dobro porazdelitev svetlobe. Uporaba: pisarne, trgovski centri, banke, avto saloni...

Корпус из декапированной листовой стали белого цвета. Продольный V raster из 99.85% алюминия, поперечная ребристая пластинка, осуществляют хорошее распределение света. Применение: офисы, торговые центры, банки, автомобильные салоны...

Kućište iz dekapiranog čeličnog lima bijele boje. Uzdužni V raster iz 99.85% aluminija i poprečne narebrane lamele omogućavaju dobru disperziju svjetlosti. Upotreba: kancelarije, trgovački centri, banke, auto saloni...

Code	Art.	W	Photo data	A	B	C	a	b	kg	dm ³	Price
11402181	114	2x18	07	297	597	100	278	578	3.1	22	
11402361	114	2x36	07	297	1197	100	278	1178	5.3	42	
11402581	114	2x58	07	297	1497	100	278	1478	8.4	52	
11403181	114	3x18	08	597	597	100	578	578	4.7	43	
11403361	114	3x36	08	597	1197	100	578	1178	8.5	83	
11404181	114	4x18	08	597	597	100	578	578	4.8	43	
11404361	114	4x36	08	597	1197	100	578	1178	9.1	83	

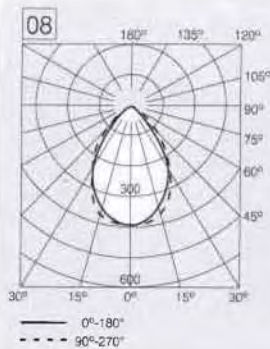

114 - 4x18		Flux CODE 70 100 100 100 64														
Index	CIE	CIE	REFLECTIONS													
SPACE K	DDR	RCS	873	871	773	771	753	751	731	711	551	531	511	331	000	
0.60	458	2	47	43	46	43	39	37	33	30	36	33	30	33	29	
0.80	558	2	54	49	53	49	46	43	40	37	43	39	37	39	36	
1.00	638	2	60	54	58	53	52	48	45	42	47	44	42	44	41	
1.25	709	1	64	57	61	56	57	52	49	47	51	49	47	48	45	
1.50	757	1	67	59	66	59	60	55	52	50	54	52	50	51	48	
2.00	828	1	72	62	70	62	65	59	57	55	58	56	55	55	53	
2.50	867	1	74	64	72	63	68	61	59	58	60	59	57	58	55	
3.00	893	1	76	65	74	64	70	63	61	60	61	60	59	59	57	
4.00	917	1	78	66	75	65	73	64	63	62	63	62	61	61	59	
5.00	929	1	79	67	76	66	74	65	64	63	64	63	62	62	59	
10.00	953	2	81	68	78	67	77	71	66	65	65	64	64	63	61	

531 - H(3.00-0.85)m - F1*F2=0.75			
AREA A*B	NUMBER OF LIGHTS REFLECTION		
	120 lx	250 lx	500 lx
10m ²	0.7	1.4	2.9
20m ²	1.2	2.5	5.0
30m ²	1.7	3.5	7.0
50m ²	2.6	5.4	10.8
70m ²	3.5	7.3	14.5
100m ²	5	10.3	20.6
150m ²	7.3	15.2	30.3



115 4x18W

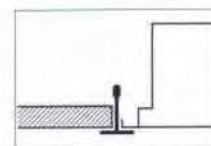
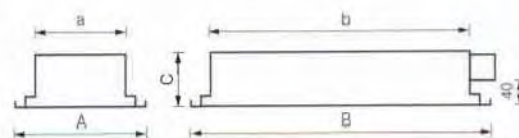

A white colour pickled steel sheet housing. The longitudinal V optical grid and transverse blades of white colour allow good efficiency of lamp. Application: offices, shops...

Omšje iz dekapirane jeklene pločevine bele barve. Vzdolžni V raster in prečne lamele bele barve omogočajo dober izkoristek svetilke. Uporaba: pisarne, trgovine...

Корпус из декапированной листовой стали белого цвета. Продольный V растр и поперечная пластинка белого цвета, осуществляют хорошую эксплуатацию светильника. Применение: офисы, магазины...

Kućište iz dekapiranog čeličnog lima bijele boje. Uzdolžni V raster i poprečne lamele bijele boje, omogućavaju dobru iskorisćenost svjetiljke. Upotreba: kancelarije, trgovine...

Code	Art.	W	Photo data	A	B	C	a	b	kg	dm ³	Price
11502181	115	2x18	09	297	597	100	278	578	3.1	22	
11502361	115	2x36	09	297	1197	100	278	1178	5.3	42	
11502581	115	2x58	09	297	1497	100	278	1478	8.4	52	
11503181	115	3x18	10	597	597	100	578	578	4.7	43	
11503361	115	3x36	10	597	1197	100	578	1178	8.5	83	
11504181	115	4x18	10	597	597	100	578	578	4.8	43	
11504361	115	4x36	10	597	1197	100	578	1178	9.1	83	

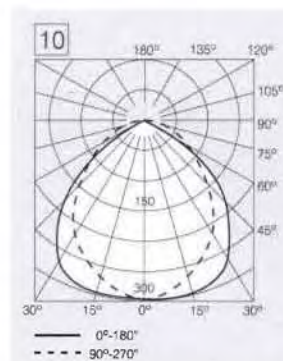

115 - 4x18				Flux CODE 62 94 100 100 64															
Index SPACE K	CIE DDR	CIE RCS	REFLECTIONS																
			873	871	773	771	753	751	731	711	551	531	511	331	000				
0.60	402	3	45	41	44	41	36	34	30	27	34	30	27	30	26				
0.80	500	3	52	47	51	47	43	41	37	34	40	36	34	36	32				
1.00	580	3	58	52	56	51	49	46	42	39	45	41	39	41	37				
1.25	654	3	63	56	60	55	54	50	47	44	49	46	44	46	42				
1.50	707	2	66	58	64	57	58	53	50	48	52	49	47	49	45				
2.00	785	2	71	62	69	61	64	58	55	53	56	54	52	53	51				
2.50	832	2	74	64	71	63	67	60	58	56	59	57	56	56	54				
3.00	863	2	75	65	73	64	69	62	60	58	61	59	58	58	56				
4.00	897	2	78	66	75	65	72	64	62	61	62	61	60	60	58				
5.00	915	2	79	67	76	66	74	65	63	62	63	62	61	61	59				
10.00	952	2	82	68	79	68	77	71	66	65	65	65	64	64	61				

531 - H(3.00-0.85)m - F1*F2=0.75			
AREA A*B	NUMBER OF LIGHTS REFLECTION		
	120 lx	250 lx	500 lx
10m ²	0.7	1.5	3.1
20m ²	1.3	2.7	5.3
30m ²	1.8	3.7	7.3
50m ²	2.7	5.6	11.2
70m ²	3.6	7.4	14.9
100m ²	5.1	10.5	21.1
150m ²	7.4	15.4	30.8



116 4x18W

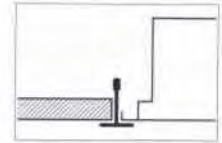
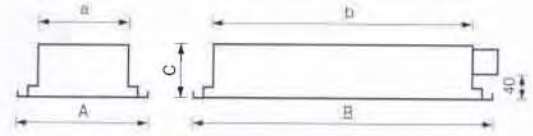

A white colour pickled steel sheet housing and frame. IP54 protection by request. Plate of polymethacrylate - OPAL. Application: laboratories, garages, dusty areas...

Ohišje in okvir iz dekapirane jeklene pločevine bele barve. Po naročilu v zaščiti IP54. Polimetakrilatna plošča - OPAL. Uporaba: laboratoriji, garaže, prašni prostori...

Корпус и рама из декапированной листовой стали белого цвета. По заказу в защите ИП54. Полиметакрилатная плитка-ОПАЛ. Применение: лаборатории, гаражи, пыльные помещения...

Kućište i okvir iz dekapiranog čeličnog lima bijele boje. Po narudžbi u zaštiti IP54. Polimetakrilatna ploča - OPAL. Upotreba: laboratoriji, garaže, zaprašene prostori...

Code	Art	W	Photo data	A	B	C	a	b	kg	dm ³	Price
11602181	116	2x18	27	297	597	100	278	578	3.1	22	
11602361	116	2x36	27	297	1197	100	278	1178	5.3	42	
11602581	116	2x58	27	297	1497	100	278	1478	8.4	52	
11603181	116	3x18	28	597	597	100	578	578	4.7	43	
11603361	116	3x36	28	597	1197	100	578	1178	8.5	83	
11604181	116	4x18	28	597	597	100	578	578	4.8	43	
11604361	116	4x36	28	597	1197	100	578	1178	9.1	83	

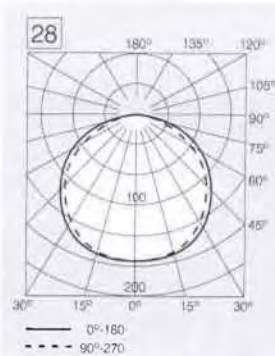

116 - 4x18		Flux CODE 44 76 97 100 59																
Index SPACE K	CIE DDR	CIE RCS	REFLECTIONS															
			873	871	773	771	753	751	731	711	551	531	511	331	000			
0.60	285	5	.36	.33	.35	.33	.27	.26	.21	.18	.25	.21	.18	.21	.17			
0.80	367	5	.43	.39	.41	.38	.33	.31	.27	.23	.30	.26	.23	.26	.22			
1.00	440	5	.48	.43	.46	.42	.38	.36	.31	.28	.35	.31	.27	.30	.26			
1.25	513	5	.52	.46	.49	.45	.43	.40	.36	.32	.39	.35	.32	.34	.30			
1.50	572	5	.56	.49	.54	.48	.47	.43	.39	.36	.42	.38	.35	.38	.34			
2.00	664	5	.61	.53	.58	.52	.53	.48	.44	.42	.46	.44	.41	.43	.39			
2.50	726	3	.64	.55	.62	.54	.57	.51	.48	.45	.50	.47	.45	.46	.43			
3.00	771	5	.66	.57	.64	.56	.59	.53	.50	.48	.52	.49	.48	.49	.45			
4.00	827	5	.69	.59	.67	.58	.63	.56	.54	.52	.54	.53	.51	.52	.49			
5.00	862	5	.71	.60	.68	.59	.65	.57	.56	.54	.56	.55	.53	.53	.51			
10.00	936	4	.74	.62	.72	.61	.70	.65	.60	.59	.59	.59	.58	.57	.55			

531 - H(3.00-0.85)m - F1*F2=0.75			
AREA A*B	NUMBER OF LIGHTS REFLECTION		
	120 lx	250 lx	500 lx
10m ²	1.0	2.1	4.2
20m ²	1.7	3.5	7.0
30m ²	2.3	4.7	9.5
50m ²	3.3	6.9	13.9
70m ²	4.4	9.1	18.2
100m ²	6.1	12.7	25.3
150m ²	8.7	18.2	36.4



117 4x18W

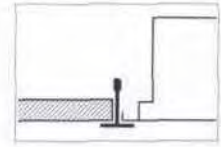
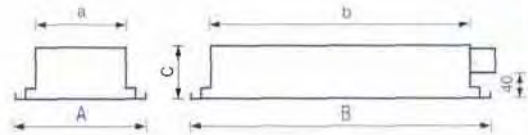

A white colour pickled steel sheet housing and frame. IP54 protection by request. Plate of polymethacrylate - DIAMOND. Application: laboratories, garages, dusty areas...

Ohišje in okvir iz dekapirane jeklene pločevine bele barve. Po naročilu v zaščiti IP54. Polimetakrilatna plošča - PRIZMATIČNA. Uporaba: laboratoriji, garaže, prašni prostori...

Корпус и рама из декапированной листовой стали белого цвета. По заказу в защите ИП54. Полиметакрилатная плитка-ОПАЛ. Применение: лаборатории, гаражи, банкинательные помещения...

Kućište i okvir iz dekapiranog čeličnog lima bijele boje. Po narudžbi u zaščiti IP54. Polimetakrilatna ploča - PRIZMATIČNA. Upotreba: laboratoriji, garaže, zaprašene prostorije...

Code	Art.	W	Photo data	A	B	C	a	b	kg	dm ³	Price
11702181	117	2x18	11	297	597	100	278	578	3.1	22	
11702361	117	2x36	11	297	1197	100	278	1178	5.3	42	
11702581	117	2x58	11	297	1497	100	278	1478	8.4	52	
11703181	117	3x18	12	597	597	100	578	578	4.7	43	
11703361	117	3x36	12	597	1197	100	578	1178	8.5	83	
11704181	117	4x18	12	597	597	100	578	578	4.8	43	
11704361	117	4x36	12	597	1197	100	578	1178	9.1	83	

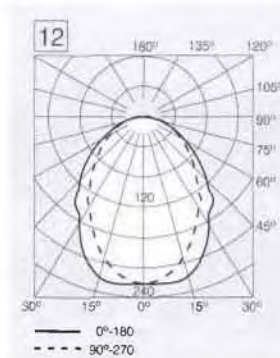

117 - 4x18		Flux CODE 52 82 98 100 66															
Index	SPACE K	CIE DDR	CIE RCS	REFLECTIONS													
				873	871	773	771	753	751	731	711	551	531	511	331	000	
0.60	345	4	43	40	42	39	33	32	27	24	31	27	24	27	23		
0.80	429	4	50	46	49	45	40	38	33	30	37	33	30	32	28		
1.00	502	4	56	50	54	49	46	43	38	35	42	38	35	37	33		
1.25	573	4	61	54	57	53	51	47	43	40	46	42	39	42	38		
1.50	628	4	64	57	62	56	55	51	47	44	49	46	43	45	41		
2.00	714	4	70	61	67	60	61	56	52	50	54	51	49	51	47		
2.50	770	3	73	63	71	62	65	59	56	53	57	55	53	54	51		
3.00	810	4	75	65	73	64	68	61	58	56	59	57	56	56	53		
4.00	858	4	78	66	75	66	72	63	62	60	62	60	59	59	56		
5.00	887	3	80	67	77	67	74	65	63	62	64	62	61	61	58		
10.00	947	3	83	70	80	69	79	73	67	66	67	66	65	65	62		

531 - H(3 00-0 85)m - F1 *F2=0.75			
AREA A*B	NUMBER OF LIGHTS REFLECTION		
	120 lx	250 lx	500 lx
10m ²	0.8	1.7	3.4
20m ²	1.4	2.9	5.8
30m ²	1.9	3.9	7.9
50m ²	2.8	5.9	11.8
70m ²	3.7	7.8	15.5
100m ²	5.2	10.9	21.8
150m ²	7.6	15.8	31.5



118 2x36W

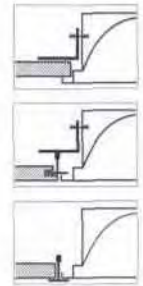
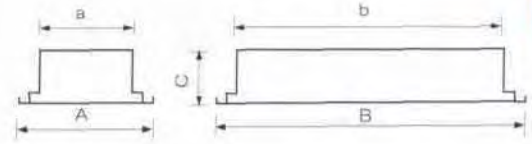

A white colour pickfret steel sheet housing. The longitudinal sheet shade allows good distribution of indirect light for decorative interior lighting. Application: meeting rooms, halls, restaurants...

Ohišje iz dekapirane jeklene pločevine bijele barve. Vzdolžni senčnik omogućava dobro porazdelitev indirektno svetlobe za dekorativno osvetlitev interierov. Uporaba: sejne sobe, avle, restavracije...

Корпус из декапированной листовой стали белого цвета. Продольный абакюр обеспечивает хорошее рассеивание света за декоративное освещение интерьера (общественных помещений). Применение: двораны для сестанок, зупа, гостиницы...

Kucište iz dekapiranog čeličnog lima bijele boje. Uzdužno sjenilo omogućuje dobru disperziju indirektno svjetlosti za dekorativnu rasvjetu interiera. Upotreba: dvorane za sastanke, aule, restorani...

Code	Art	W	Photo data	BASE	A	B	C	a	b	kg	dm ³	Price
11802361	118	2x36 PL	05	2G11	597	597	160	575	575	8.5	63	
11802551	118	2x55 EL	05	2G11	597	597	160	575	575	7.8	63	

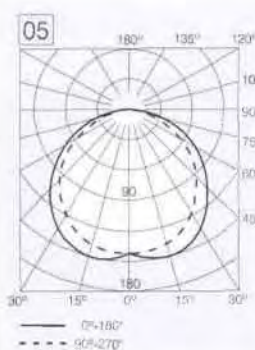

118 - 2x36PL				Flux CODE 49 83 98 100 42															
Index SPACE K	CIE DDR	CIE RCS	REFLECTIONS																
			873	871	773	771	753	751	731	711	551	531	511	331	000				
0.60	317	5	27	25	26	24	25	19	16	14	19	16	14	16	13				
0.80	408	5	31	28	30	28	30	23	20	18	23	20	18	20	17				
1.00	485	5	35	31	34	31	33	27	24	21	26	23	21	23	20				
1.25	560	4	38	34	36	33	38	30	27	25	29	26	25	26	23				
1.50	617	4	41	36	39	35	39	32	29	27	31	29	27	28	26				
2.00	705	4	44	38	42	38	40	35	33	31	34	32	31	32	29				
2.50	762	3	46	40	45	39	41	37	35	34	36	35	33	34	32				
3.00	802	4	48	41	46	40	43	38	37	35	38	36	35	36	34				
4.00	850	4	49	42	48	41	45	40	39	38	39	38	37	37	36				
5.00	879	4	51	43	49	42	47	41	40	39	40	39	38	38	37				
10.00	939	4	53	44	51	44	50	46	42	42	42	42	41	41	39				

531 - H(3.00-0.85)m - F1*F2=0.75			
AREA A*B	NUMBER OF LIGHTS REFLECTION		
	120 lx	250 lx	500 lx
10m ²	1.2	2.6	5.1
20m ²	2.1	4.3	8.6
30m ²	2.8	5.9	11.7
50m ²	4.2	8.7	17.4
70m ²	5.5	11.5	22.9
100m ²	7.7	16.1	32.2
150m ²	11.2	23.3	46.6



119 2x36W

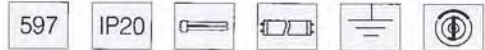
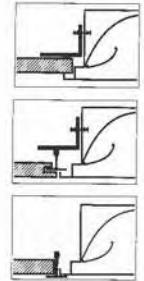
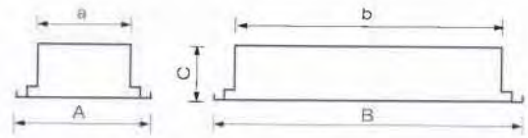

A white colour pickled steel sheet housing. The longitudinal perforated sheet shade allows good distribution of indirect light for decorative interior lighting. Application: meeting rooms, halls, restaurants.

Ohišje iz dekapirane jeklene pločevine bele barve. Vzdolžni perforiran senčnik omogoča dobro porazdelitev indirektno svetlobe za dekorativno osvetlitev interierov. Uporaba: sejne sobe, avle, restavracije.

Корпус из декапированной листовой стали белого цвета. Продольный перфорированный абжур осуществляет хорошее рассеяние света за декоративное освещение интерьера (внутренность помещений). Применение: двораны для сестанок, аули, гостиницы...

Kućište iz dekapiranog čeličnog lima bijele boje. Uzdužno perforirano sjenilo omogućuje dobru disperziju indirektno svetlosti za dekorativnu rasvjetu interiera. Upotreba: dvorane za sastanke, aule, restorani.

Code	Art.	W	Photo data	BASE	A	B	C	a	b	kg	dm ³	Price
11902361	119	2x36 PL	29	2G11	597	597	160	575	575	8.5	63	
11902551	119	2x55 EL	29	2G11	597	597	160	575	575	7.8	63	
11904361	119	4x36	29	G13	597	1260	160	575	1238	15.8	126	

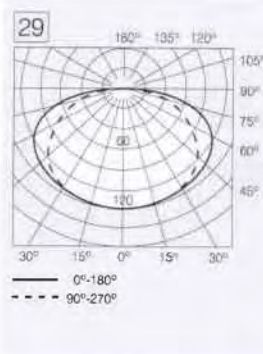

119 - 2x36PL				Flux CODE 37 67 89 100 47											
Index SPACE K	CIE DDR	CIE RCS	REFLECTIONS												
			873	871	773	771	753	751	731	711	551	531	511	331	000
0.60	241	7	27	25	26	25	20	19	15	12	18	15	12	15	11
0.80	316	7	32	29	31	28	24	23	19	16	22	19	16	18	15
1.00	382	7	36	32	35	32	28	26	22	19	25	22	19	22	18
1.25	451	7	40	35	37	34	32	29	26	23	29	25	23	25	21
1.50	507	7	42	37	41	36	35	32	28	25	31	28	25	27	24
2.00	595	7	46	40	45	39	39	36	33	30	35	32	30	31	28
2.50	657	7	49	42	47	41	42	38	35	33	37	35	33	34	31
3.00	703	7	51	44	49	43	45	40	37	35	39	37	35	36	33
4.00	763	7	53	45	51	45	48	42	40	38	41	39	38	38	36
5.00	801	7	55	46	53	46	50	44	42	40	43	41	40	40	38
10.00	889	7	58	49	56	48	54	50	46	45	46	45	44	44	42

AREA A*B	NUMBER OF LIGHTS REFLECTION		
	120 lx	250 lx	500 lx
10m ²	1.3	2.8	5.5
20m ²	2.2	4.5	9.1
30m ²	2.9	6.1	12.2
50m ²	4.2	8.8	17.6
70m ²	5.5	11.5	23.0
100m ²	7.7	15.9	31.9
150m ²	11.0	22.8	45.7



122 4x18W

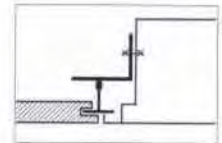
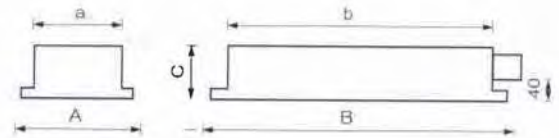

A white colour pickled steel sheet housing. The longitudinal and transverse polished parabolic optical grid of 99.90% aluminium allows very good distribution of light (60...200 cd/m²). Application: banks, insurance company offices, offices with video terminals, shopping centres...

Ohišje iz dekapirane jeklene pločevine bele barve. Vzdoižni in prečni sijajni parabolični raster iz 99.90% aluminija omogoča zelo dobro porazdelitev svetlobe (60...200 cd/m²). Uporaba: banke, zavarovalnice, pisarne z video terminali, trgovski centri...

Корпус из декапированной листовой стали белого цвета. Продольный и поперечный полублестящий параболический растр из 99.90% алюминия осуществляет особенно хорошее распределение света (60...200 лд/м²). Применение: банки, страховые агентства, офисы с видео терминалами, торговые центры...

Kućište iz dekapiranog čeličnog lima bijele boje. Uzdužni i poprečni sjajni parabolični raster iz 99.90% aluminija omogućava vrlo dobru disperziju svjetlosti (60...200 cd/m²). Upotreba: banke, osiguravajući zavodi, kancelarije s video terminalima, trgovački centri...

Code	Art	W	Photo data	A	B	C	a	b	kg	dm ³	Price
12202181	122	2x18	03	297	597	100	275	575	3.6	22	
12202361	122	2x36	03	297	1197	100	275	1175	6.4	43	
12202581	122	2x58	03	297	1497	100	275	1475	9.3	53	
12203181	122	3x18	04	597	597	100	575	575	5.6	43	
12203361	122	3x36	04	597	1197	100	575	1175	11.1	84	
12204181	122	4x18	04	597	597	100	575	575	5.6	43	
12204361	122	4x36	04	597	1197	100	575	1175	11.7	84	

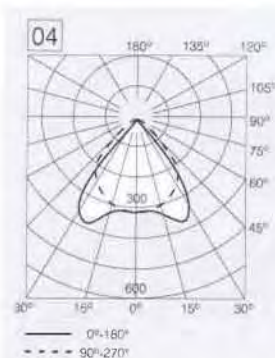

122 - 4x18		Flux CODE 78 100 100 100 59														
Index	CIE	CIE	REFLECTIONS													
SPACE K	DDR	RCS	873	871	773	771	753	751	731	711	551	531	511	331	000	
0.60	538	1	47	43	46	43	40	38	35	33	37	35	33	34	32	
0.80	621	1	53	48	51	47	45	43	40	38	42	40	38	39	37	
1.00	692	1	57	51	56	51	50	47	44	42	46	44	42	43	41	
1.25	752	1	61	54	58	53	54	50	48	46	49	47	46	47	44	
1.50	794	-	63	56	62	55	57	52	50	48	52	50	48	49	47	
2.00	856	-	67	58	65	58	61	56	54	52	55	53	52	53	50	
2.50	892	-	69	60	67	59	64	57	56	55	56	55	54	55	52	
3.00	917	-	71	61	69	60	66	59	58	56	58	57	56	56	54	
4.00	938	-	72	62	70	61	68	60	59	58	59	58	57	57	55	
5.00	950	-	73	62	71	61	69	61	60	59	59	59	58	58	56	
10.00	972	1	75	63	73	62	71	66	61	61	61	60	60	59	57	

531 - H(3.00-0.85)m - F1*F2=0.75			
AREA A*B	NUMBER OF LIGHTS REFLECTION		
	120lx	250lx	500lx
10m ²	0.7	1.5	2.9
20m ²	1.3	2.6	5.2
30m ²	1.8	3.7	7.3
50m ²	2.7	5.7	11.5
70m ²	3.7	7.7	15.4
100m ²	5.3	11	21.9
150m ²	7.7	16.1	32.3



124 4x18W

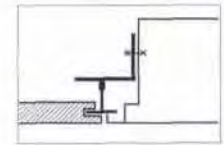
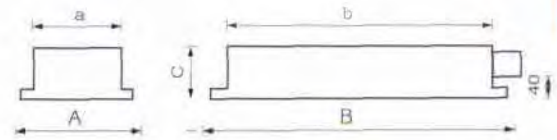

A white colour pickled steel sheet housing. The longitudinal V optical grid and fluted transverse blades of 99.85% aluminium allow good distribution of light. Application: offices, shopping centres, banks, car shows.

Ohišje iz dekapirane jeklene pločevine bele barve. Vzdolžni V raster iz 99.85% aluminija in prečne narebrane lamele omogočajo dobro porazdelitev svetlobe. Uporaba: pisarne, trgovski centri, banke, avto saloni...

Корпус из декапированной листовой стали белого цвета. Продольный V raster из 99.85% алюминия, поперечная ребристая пластина, осуществляют хорошее распределение света. Применение: офисы, торговые центры, банки, автомобильные салоны...

Kućište iz dekapiranog čeličnog lima bijele boje. Uzdužni V raster iz 99.85% aluminija i poprečne narebrane lamele omogućavaju dobru disperziju svjetlosti. Upotreba: kancelarije, trgovački centri, banke, auto saloni...

Code	Art.	W	Photo data	A	B	C	a	b	kg	dm ³	Price
12402181	124	2x18	07	297	597	100	278	578	3.3	22	
12402361	124	2x36	07	297	1197	100	278	1178	6.0	43	
12402581	124	2x58	07	297	1497	100	278	1478	9.1	53	
12404181	124	4x18	08	597	597	100	578	578	5.2	43	
12404361	124	4x36	08	597	1197	100	578	1178	9.4	84	

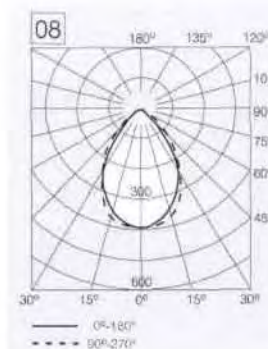

124 - 4x18				Flux CODE 70 100 100 100 64															
Index SPACE K	CIE DDR	CIE RCS	REFLECTIONS	873	871	773	771	753	751	731	711	551	531	511	331	000			
0.60	458	2	.47	.43	.46	.43	.39	.37	.33	.30	.36	.33	.30	.33	.29				
0.80	558	2	.54	.49	.53	.49	.46	.43	.40	.37	.43	.39	.37	.39	.36				
1.00	638	2	.60	.54	.58	.53	.52	.48	.45	.42	.47	.44	.42	.44	.41				
1.25	709	1	.64	.57	.61	.56	.57	.52	.49	.47	.51	.49	.47	.48	.45				
1.50	757	1	.67	.59	.66	.59	.60	.55	.52	.50	.54	.52	.50	.51	.48				
2.00	828	1	.72	.62	.70	.62	.65	.59	.57	.55	.58	.56	.55	.55	.53				
2.50	867	1	.74	.64	.72	.63	.68	.61	.59	.58	.60	.59	.57	.58	.55				
3.00	893	1	.76	.65	.74	.64	.70	.63	.61	.60	.61	.60	.59	.59	.57				
4.00	917	1	.78	.66	.75	.65	.73	.64	.63	.62	.63	.62	.61	.61	.59				
5.00	929	1	.79	.67	.76	.66	.74	.65	.64	.63	.64	.63	.62	.62	.59				
10.00	953	2	.81	.68	.78	.67	.77	.71	.66	.65	.65	.64	.64	.63	.61				

531 - H(3.00-0.85)m - F1 * F2 = 0.75			
AREA A*B	NUMBER OF LIGHTS REFLECTION		
	120 lx	250 lx	500 lx
10m ²	0.7	1.4	2.9
20m ²	1.2	2.5	5.0
30m ²	1.7	3.5	7.0
50m ²	2.6	5.4	10.8
70m ²	3.5	7.3	14.5
100m ²	5.0	10.3	20.6
150m ²	7.3	15.2	30.3



125 4x18W

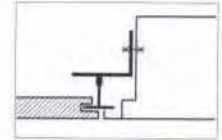
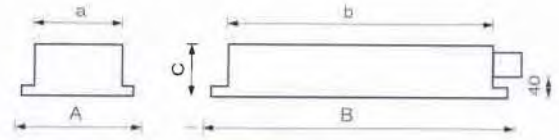

A white colour pickled steel sheet housing. The longitudinal V optical grid and transverse blades of white colour allow good efficiency of lamp Application: offices, shops.

Ohišje iz dekapirane jeklene pločevine bele barve. Vzdolžni V raster in prečne lamele bele barve omogočajo dober izkoristek svetilke. Uporaba: pisarne, trgovine.

Корпус из декапированной листовой стали белого цвета. Продольный V raster и поперечная пластинка белого цвета осуществляют хорошую эксплуатацию светильника. Применение: офисы, магазины...

Kućište iz dekapiranog čeličnog lima bijele boje. Uzdužni V raster i poprečne lamele bijele boje omogućavaju dobru iskorištenost svjetiljke. Upotreba: kancelarije, trgovine...

Code	Art	W	Photo data	A	B	C	a	b	kg	dm ³	Price
12502181	125	2x18	09	297	597	100	278	578	3.3	22	
12502361	125	2x36	09	297	1197	100	278	1178	6.0	43	
12502581	125	2x58	09	297	1497	100	278	1478	9.1	53	
12504181	125	4x18	10	597	597	100	578	578	5.2	43	
12504361	125	4x36	10	597	1197	100	578	1178	9.4	84	

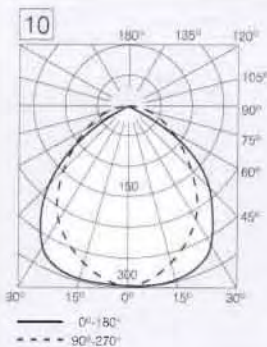

125 - 4x18				Flux CODE 62 94 100 100 64																					
Index	CIE	CIE	REFLECTIONS																						
SPACE K	DDR	RCS		873	871	773	771	753	751	731	711	551	531	511	331	000									
0.60	402	3		45	41	44	41	36	34	30	27	34	30	27	30	26									
0.80	500	3		52	47	51	47	43	41	37	34	40	36	34	36	32									
1.00	580	3		58	52	56	51	49	46	42	39	45	41	39	41	37									
1.25	654	3		63	56	60	55	54	50	47	44	49	46	44	46	42									
1.50	707	2		66	58	64	57	58	53	50	48	52	49	47	49	45									
2.00	785	2		71	62	69	61	64	58	55	53	56	54	52	53	51									
2.50	832	2		74	64	71	63	67	60	58	56	59	57	56	56	54									
3.00	863	2		75	65	73	64	69	62	60	58	61	59	58	58	56									
4.00	897	2		78	66	75	65	72	64	62	61	62	61	60	60	58									
5.00	915	2		79	67	76	66	74	65	63	62	63	62	61	61	59									
10.00	952	2		82	68	79	68	77	71	66	65	65	65	64	64	61									

531 - H(3.00-0.85)m - F1*F2=0.75			
AREA A*B	NUMBER OF LIGHTS REFLECTION		
	120lx	250lx	500lx
10m ²	0.7	1.5	3.1
20m ²	1.3	2.7	5.3
30m ²	1.8	3.7	7.3
50m ²	2.7	5.6	11.2
70m ²	3.6	7.4	14.9
100m ²	5.1	10.5	21.1
150m ²	7.4	15.4	30.8



126 4x18W

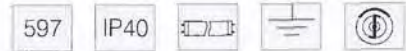
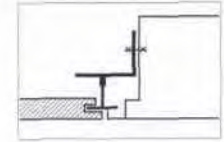
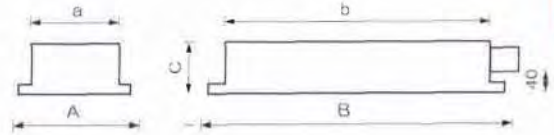

A white colour pickled steel sheet housing and frame. IP54 protection by request. Plate of polymethacrylate - OPAL. Application: laboratories, garages, dusty areas...

Ohišje in okvir iz dekapirane jeklene pločevine bele barve. Po naročilu v zaščiti IP54. Polimetakrilatna plošča - OPAL. Uporaba: laboratoriji, garaže, prašni prostori...

Корпус и рама из декапированной листовой стали белого цвета. По заказу в защите ИП54. Полиметакрилатная плита - ОПАЛ. Применение: лаборатория, гаражи, пыльные помещения...

Kućište i okvir iz dekapiranog čeličnog lima bijele boje. Po narudžbi u zaštiti IP54. Polimetakrilatna ploča - OPAL. Upotreba: laboratoriji, garaže, zaprašene prostori...

Code	Art.	W	Photo data	A	B	C	a	b	kg	dm ³	Price
12602181	126	2x18	27	297	597	100	278	578	3.7	22	
12602361	126	2x36	27	297	1197	100	278	1178	7.0	43	
12602581	126	2x58	27	297	1497	100	278	1478	9.7	53	
12604181	126	4x18	28	597	597	100	578	578	6.0	43	
12604361	126	4x36	28	597	1197	100	578	1178	10.9	84	

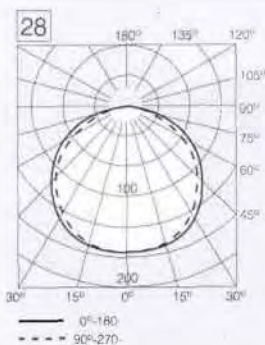

126 - 4x18			Flux CODE 44 76 97 100 59															
Index	CIE	CIE	REFLECTIONS															
SPACE K	DDR	RCS	873	871	773	771	753	751	731	711	551	531	511	331	000			
0.60	285	5	.36	.33	.35	.33	.27	.26	.21	.18	.25	.21	.18	.21	.17			
0.80	367	5	.43	.39	.41	.38	.33	.31	.27	.23	.30	.26	.23	.26	.22			
1.00	440	5	.48	.43	.46	.42	.38	.36	.31	.28	.35	.31	.27	.30	.26			
1.25	513	5	.52	.46	.49	.45	.43	.40	.36	.32	.39	.35	.32	.34	.30			
1.50	572	5	.56	.49	.54	.48	.47	.43	.39	.36	.42	.38	.35	.38	.34			
2.00	664	5	.61	.53	.58	.52	.53	.48	.44	.42	.46	.44	.41	.43	.39			
2.50	726	3	.64	.55	.62	.54	.57	.51	.48	.45	.50	.47	.45	.46	.43			
3.00	771	5	.66	.57	.64	.56	.59	.53	.50	.48	.52	.49	.48	.49	.45			
4.00	827	5	.69	.59	.67	.58	.63	.56	.54	.52	.54	.53	.51	.52	.49			
5.00	862	5	.71	.60	.68	.59	.65	.57	.56	.54	.56	.55	.53	.53	.51			
10.00	936	4	.74	.62	.72	.61	.70	.65	.60	.59	.59	.59	.58	.57	.55			

531 - H(3.00-0.85)m - F1*F2=0.75			
AREA A*B	NUMBER OF LIGHTS REFLECTION		
	120 lx	250 lx	500 lx
10m ²	1.0	2.1	4.2
20m ²	1.7	3.5	7.0
30m ²	2.3	4.7	9.5
50m ²	3.3	6.9	13.9
70m ²	4.4	9.1	18.2
100m ²	6.1	12.7	25.3
150m ²	8.7	18.2	36.4



127 4x18W

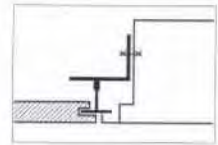
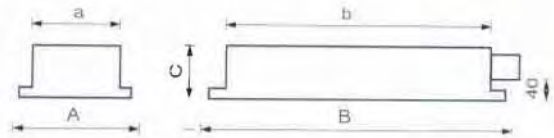

A white colour pickled steel sheet housing and frame. IP54 protection by request. Plate of polymethacrylate - DIAMOND. Application: laboratories, garages, dusty areas...

Ohišje in okvir iz dekapirane jeklene pločevine bele barve. Po naročilu v zaščiti IP54. Polimetakrilatna plošča - PRIZMATIČNA. Uporaba: laboratoriji, garaže, prašni prostori...

Корпус и рама из декапированной листовой стали белого цвета. По заказу в защите ИП54. Подметакрилатная плитка - ПРИЗМАТИЧЕСКАЯ. Применение: лаборатории, гаражи, пыльные помещения...

Kućište i okvir iz dekapiranog čeličnog lima bijele boje. Po narudžbi u zaštiti IP54. Polimetakrilatna ploča - PRIZMATIČNA. Upotreba: laboratoriji, garaže, zaprašene prostorije...

Code	Art	W	Photo data	A	B	C	a	b	kg	dm ³	Price
12702181	127	2x18	11	297	597	100	278	578	3.7	22	
12702361	127	2x36	11	297	1197	100	278	1178	7.0	43	
12702581	127	2x58	11	297	1497	100	278	1478	9.7	53	
12704181	127	4x18	12	597	597	100	578	578	6.0	43	
12704361	127	4x36	12	597	1197	100	578	1178	10.9	84	

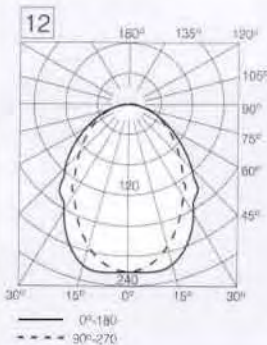

Index SPACE K	CIE DDR	CIE RCS	REFLECTIONS															
			873	871	773	771	753	751	731	711	551	531	511	331	000			
0.60	345	4	.43	.40	.42	.39	.33	.32	.27	.24	.31	.27	.24	.27	.23			
0.80	429	4	.50	.46	.49	.45	.40	.38	.33	.30	.37	.33	.30	.32	.28			
1.00	502	4	.56	.50	.54	.49	.46	.43	.38	.35	.42	.38	.35	.37	.33			
1.25	573	4	.61	.54	.57	.53	.51	.47	.43	.40	.46	.42	.39	.42	.38			
1.50	628	4	.64	.57	.62	.56	.55	.51	.47	.44	.49	.46	.43	.45	.41			
2.00	714	4	.70	.61	.67	.60	.61	.56	.52	.50	.54	.51	.49	.51	.47			
2.50	770	3	.73	.63	.71	.62	.65	.59	.56	.53	.57	.55	.53	.54	.51			
3.00	810	4	.75	.65	.73	.64	.68	.61	.58	.56	.59	.57	.56	.56	.53			
4.00	858	4	.78	.66	.75	.66	.72	.63	.62	.60	.62	.60	.59	.59	.56			
5.00	887	3	.80	.67	.77	.67	.74	.65	.63	.62	.64	.62	.61	.61	.58			
10.00	947	3	.83	.70	.80	.69	.79	.73	.67	.66	.67	.66	.65	.65	.62			

AREA A*B	NUMBER OF LIGHTS REFLECTION		
	120 lx	250 lx	500 lx
10m ²	0.8	1.7	3.4
20m ²	1.4	2.9	5.8
30m ²	1.9	3.9	7.9
50m ²	2.8	5.9	11.8
70m ²	3.7	7.8	15.5
100m ²	5.2	10.9	21.8
150m ²	7.6	15.8	31.5



131 4x18W

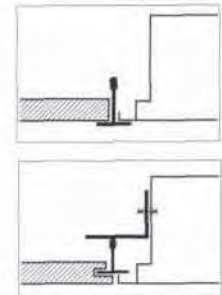
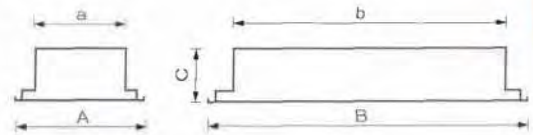

A white colour pickled steel sheet housing. The longitudinal and transverse highly polished parabolic optical grid of 99.99% aluminium allows excellent distribution of light (50...200 cd/m²). Application: banks, insurance company offices, offices with video terminals, drawing offices...

Ohišje iz dekapirane jeklene pločevine bele barve. Vzdolžni in prečni visoko sijajni parabolični raster iz 99.99% aluminija omogoča izredno porazdelitev svetlobe (50...200 cd/m²). Uporaba: banke, zavarovalnice, pisarne z video terminali, projektivni biroji...

Корпус из деканпированной листовой стали белого цвета. Продольный и поперечный блестящий параболический raster из 99.99% алюминия осуществляет особенное распределение света (50...200 cd/m²). Применение: банки, страховые агентства, офисы с видео терминалами, проектные бюро...

Kućište iz dekapiranog čeličnog lima bijele boje. Uzdužni i poprečni visoko sjajni parabolični raster iz 99.99% aluminija omogućava izvanrednu disperziju svjetlosti (50...200 cd/m²). Upotreba: banke, osiguravajući zavodi, kancelarije s video terminalima, projekt biroji...

Code	Art.	W	Photo data	A	B	C	a	b	kg	dm ³	Price
13102181	131	2x18	01	312	622	100	278	578	4.0	23	
13102361	131	2x36	01	312	1247	100	278	1178	6.0	47	
13102581	131	2x58	01	312	1547	100	278	1478	9.8	58	
13103181	131	3x18	02	622	622	100	578	578	5.9	44	
13103361	131	3x36	02	622	1247	100	578	1178	11.4	89	
13104181	131	4x18	02	622	622	100	578	578	6.0	44	
13104361	131	4x36	02	622	1247	100	578	1178	12.0	89	

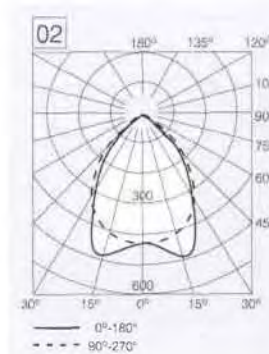

131 - 4x18				Flux CODE 81 100 100 100 67															
Index SPACE K	CIE DDR	CIE RCS	REFLECTIONS	873	871	773	771	753	751	731	711	551	531	511	331	000			
0.60	562	1		55	51	54	50	47	45	41	39	44	41	39	41	38			
0.80	641	-		61	56	60	55	53	50	47	45	50	47	44	46	43			
1.00	708	-		66	59	65	59	58	55	52	49	54	51	49	51	48			
1.25	765	-		70	62	67	62	63	58	56	53	57	55	53	54	52			
1.50	805	-		73	64	71	64	66	61	58	56	60	58	56	57	54			
2.00	865	-		77	67	75	66	71	64	62	61	63	62	60	61	58			
2.50	900	-		80	69	77	68	74	66	65	63	65	64	63	63	61			
3.00	924	-		81	70	79	69	76	68	66	65	66	65	64	64	62			
4.00	945	-		83	71	81	70	78	69	68	67	68	67	66	66	64			
5.00	956	-		84	71	82	71	79	70	69	68	68	68	67	67	64			
10.00	977	-		86	72	83	72	82	76	71	70	70	69	69	68	66			

531 - H(3.00-0.85)m - F1*F2=0.75			
AREA A*B	NUMBER OF LIGHTS REFLECTION		
	120 lx	250 lx	500 lx
10m ²	0.6	1.2	2.5
20m ²	1.1	2.2	4.5
30m ²	1.5	3.2	6.3
50m ²	2.4	5.0	9.9
70m ²	3.2	6.7	13.4
100m ²	4.6	9.5	19.0
150m ²	6.7	14.0	28.0



132 4x18W

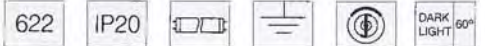
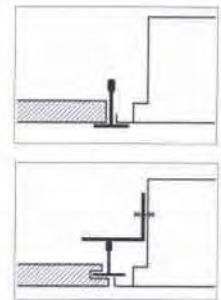
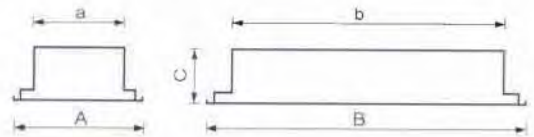

A white colour pickled steel sheet housing. The longitudinal and transverse polished parabolic optical grid of 99.90% aluminium allows very good distribution of light (60..200 cd/m²). Application: banks, insurance company offices, offices with video terminals, shopping centres...

Ohiše iz dekapirane jeklene pločevine bele barve. Vz dolžni in prečni sijajni parabolični raster iz 99.90% aluminija omogoča zelo dobro porazdelitev svetlobe (60..200 cd/m²). Uporaba: banke, zavarovalnice, pisarne z video terminali, trgovski centri...

Корпус из деканпированной листовой стали белого цвета. Продольный и поперечный полудубляющийся параболический растр из 99.90% алюминия осуществляет особенно хорошее распределение света (60..200 нд/м²). Применение: банки, страховые агентства, офисы с видео терминалами, торговые центры...

Kućište iz dekapiranog čeličnog lima bijele boje. Uzdužni i poprečni sijajni parabolični raster iz 99.90% aluminija omogućava vrlo dobru disperziju svjetlosti (60..200 cd/m²). Upotreba: banke, osiguravajući zavodi, kancelarije s video terminalima, trgovački centri...

Code	Art.	W	Photo data	A	B	C	a	b	kg	dm ³	Price
13202181	132	2x18	03	312	622	100	278	578	3.8	23	
13202361	132	2x36	03	312	1247	100	278	1178	5.8	47	
13202581	132	2x58	03	312	1547	100	278	1478	9.5	58	
13203181	132	3x18	04	622	622	100	578	578	5.7	44	
13203361	132	3x36	04	622	1247	100	578	1178	11.1	89	
13204181	132	4x18	04	622	622	100	578	578	5.8	44	
13204361	132	4x36	04	622	1247	100	578	1178	11.7	89	

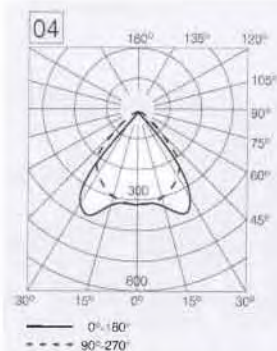

132 - 4x18		Flux CODE 78 100 100 100 59														
Index	CIE	CIE	REFLECTIONS													
SPACE K	DDR	RCS	873	871	773	771	753	751	731	711	551	531	511	331	000	
0.60	.538	1	47	43	46	43	40	38	35	33	37	35	33	34	32	
0.80	621	1	53	48	51	47	45	43	40	38	42	40	38	39	37	
1.00	692	1	57	51	56	51	50	47	44	42	46	44	42	43	41	
1.25	752	1	61	54	58	53	54	50	48	46	49	47	46	47	44	
1.50	794	-	63	56	62	55	57	52	50	48	52	50	48	49	47	
2.00	856	-	67	58	65	58	61	56	54	52	55	53	52	53	50	
2.50	892	-	69	60	67	59	64	57	56	55	56	55	54	55	52	
3.00	917	-	71	61	69	60	66	59	58	56	58	57	56	56	54	
4.00	938	-	72	62	70	61	68	60	59	58	59	58	57	57	55	
5.00	950	-	73	62	71	61	69	61	60	59	59	58	58	58	56	
10.00	972	1	75	63	73	62	71	66	61	61	61	60	60	59	57	

531 - H(3.00-0.85)m - F1*F2=0.75			
AREA A*B	NUMBER OF LIGHTS REFLECTION		
	120lx	250lx	500lx
10m ²	0.3	0.6	1.2
20m ²	0.5	1.1	2.1
30m ²	0.7	1.5	3.0
50m ²	1.1	2.3	4.6
70m ²	1.5	3.1	6.2
100m ²	2.1	4.4	8.8
150m ²	3.1	6.5	13.0



134 4x18W

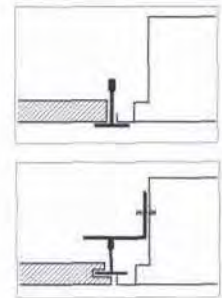
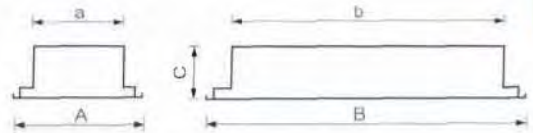

A white colour pickled steel sheet housing. The longitudinal V optical grid and fluted transverse blades of 99.85% aluminium allow good distribution of light.
Application: offices, shopping centres, banks, car shows...

Ohlášje iz dekapirane jeklene pločevine bele barve. Vzdolžni V raster iz 99.85% aluminija in prečne narebrne lamele omogočajo dobro porazdelitev svetlobe.
Uporaba: pisarne, trgovski centri, banke, avto saloni...

Корпус из декапированной листовой стали белого цвета. Продольный V raster из 99.85% алюминия, поперечная ребристая пластинка, осуществляют хорошее распределение света. Применение: офисы, торговые центры, банки, автомобильные салоны...

Kućišće iz dekapiranog čeličnog lima bijele boje. Uzdužni V raster iz 99.85% aluminija i poprečne narebrane lamele omogućavaju dobru disperziju svjetlosti.
Upotreba: kancelarije, trgovački centri, banke, auto saloni...

Code	Art.	W	Photo data	A	B	C	a	b	kg	dm ³	Price
13402181	134	2x18	07	312	622	100	278	578	3.1	23	
13402361	134	2x36	07	312	1247	100	278	1178	5.7	47	
13402581	134	2x58	07	312	1547	100	278	1478	8.8	58	
13404181	134	4x18	08	622	622	100	578	578	5.5	44	
13404361	134	4x36	08	622	1247	100	578	1178	9.6	89	

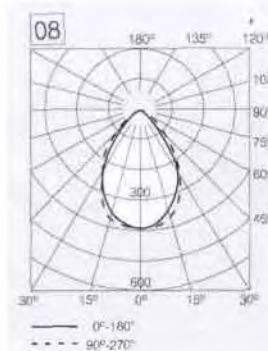

134 - 4x18			Flux CODE 70 100 100 100 64															
Index SPACE K	CIE DDR	CIE RCS	REFLECTIONS															
			873	871	773	771	753	751	731	711	551	531	511	331	000			
0.60	458	2	47	43	46	43	39	37	33	30	36	33	30	33	29			
0.80	558	2	54	49	53	49	46	43	40	37	43	39	37	39	36			
1.00	638	2	60	54	58	53	52	48	45	42	47	44	42	44	41			
1.25	709	1	64	57	61	56	57	52	49	47	51	49	47	48	45			
1.50	757	1	67	59	66	59	60	55	52	50	54	52	50	51	48			
2.00	828	1	72	62	70	62	65	59	57	55	58	56	55	55	53			
2.50	867	1	74	64	72	63	68	61	59	58	60	59	57	58	55			
3.00	893	1	76	65	74	64	70	63	61	60	61	60	59	59	57			
4.00	917	1	78	66	75	65	73	64	63	62	63	62	61	61	59			
5.00	929	1	79	67	76	66	74	65	64	63	64	63	62	62	59			
10.00	953	2	81	68	78	67	77	71	66	65	65	64	64	63	61			

531 - H(3.00-0.85)m - F1*F2=0.75			
AREA A*B	NUMBER OF LIGHTS REFLECTION		
	120 lx	250 lx	500 lx
10m ²	0.7	1.4	2.9
20m ²	1.2	2.5	5.0
30m ²	1.7	3.5	7.0
50m ²	2.6	5.4	10.8
70m ²	3.5	7.3	14.5
100m ²	5.0	10.3	20.6
150m ²	7.3	15.2	30.3



135 4x18W

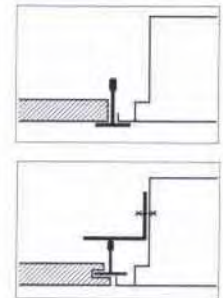
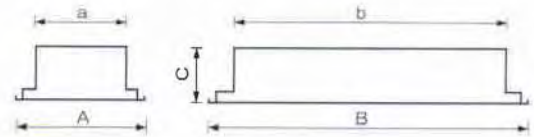

A white colour pickled steel sheet housing. The longitudinal V optical grid and transverse blades of white colour allow good efficiency of lamp. Application: offices, shops...

Ohišje iz dekapirane jeklene pločevine bele barve. Vzdolžni V raster in prečne lamele bele barve omogočajo dober izkoristek svetilke. Uporaba: pisarne, trgovine...

Корпус из декапированной листовой стали белого цвета. Продольный V raster и поперечная пластинка белого цвета осуществляют хорошую эксплуатацию светильника. Применение: офисы, магазины...

Kućište iz dekapiranog čeličnog lima bijele boje. Uzdužni V raster i poprečne lamele bijele boje omogućavaju dobru iskoristenoost svjetiljke. Upotreba: kancelarije, trgovine...

Code	Art	W	Photo data	A	B	C	a	b	kg	dm ³	Price
13502181	135	2x18	09	312	622	100	278	578	3.1	23	
13502361	135	2x36	09	312	1247	100	278	1178	5.7	47	
13502581	135	2x58	09	312	1547	100	278	1478	8.8	58	
13504181	135	4x18	10	622	622	100	578	578	5.5	44	
13504361	135	4x36	10	622	1247	100	578	1178	9.6	89	

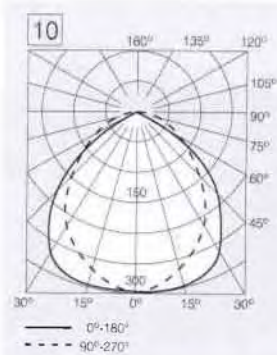

135 - 4x18				Flux CODE 62 94 100 100 64											
Index	CIE	CIE	REFLECTIONS												
SPACE K	DDR	RCS	873	871	773	771	753	751	731	711	551	531	511	331	000
0.60	402	3	.45	.41	.44	.41	.36	.34	.30	.27	.34	.30	.27	.30	.26
0.80	500	3	.52	.47	.51	.47	.43	.41	.37	.34	.40	.36	.34	.36	.32
1.00	580	3	.58	.52	.56	.51	.49	.46	.42	.39	.45	.41	.39	.41	.37
1.25	654	3	.63	.56	.60	.55	.54	.50	.47	.44	.49	.46	.44	.46	.42
1.50	707	2	.66	.58	.64	.57	.58	.53	.50	.48	.52	.49	.47	.49	.45
2.00	785	2	.71	.62	.69	.61	.64	.58	.55	.53	.56	.54	.52	.53	.51
2.50	832	2	.74	.64	.71	.63	.67	.60	.58	.56	.59	.57	.56	.56	.54
3.00	863	2	.75	.65	.73	.64	.69	.62	.60	.58	.61	.59	.58	.58	.56
4.00	897	2	.78	.66	.75	.65	.72	.64	.62	.61	.62	.61	.60	.60	.58
5.00	915	2	.79	.67	.76	.66	.74	.65	.63	.62	.63	.62	.61	.61	.59
10.00	952	2	.82	.68	.79	.68	.77	.71	.66	.65	.65	.65	.64	.64	.61

531 - H(3.00-0.85)m - F1*F2=0.75			
AREA A*B	NUMBER OF LIGHTS REFLECTION		
	120lx	250lx	500lx
10m ²	0.7	1.5	3.1
20m ²	1.3	2.7	5.3
30m ²	1.8	3.7	7.3
50m ²	2.7	5.6	11.2
70m ²	3.6	7.4	14.9
100m ²	5.1	10.5	21.1
150m ²	7.4	15.4	30.8



136 4x18W

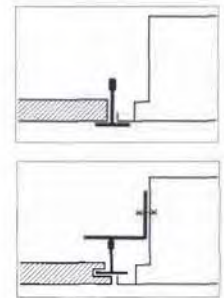
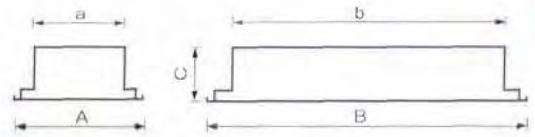

A white colour pickled steel sheet housing and frame. IP54 protection by request. Plate of polymethacrylate - OPAL. Application: laboratories, garages, dusty areas...

Ohišje in okvir iz dekapirane jeklene pločevine bele barve. Po naročilu v zaščiti IP54. Polimetakrilatna plošča - OPAL. Uporaba: laboratoriji, garaže, prašni prostor...

Корпус и рама из декапированной листовой стали белого цвета. По заказу в защите ИП54. Полиметакрилатная плитка-ОПАЛ. Применение: лаборатории, гаражи, пыльные помещения...

Kućište i okvir iz dekapiranog čeličnog lima bijele boje. Po narudžbi u zaštiti IP54. Polimetakrilatna ploča - OPAL. Upotreba: laboratoriji, garaže, zaprašene prostori...

Code	Art.	W	Photo data	A	B	C	a	b	kg	dm ³	Price
13602181	136	2x18	27	312	622	100	278	578	3.4	23	
13602361	136	2x36	27	312	1247	100	278	1178	6.6	47	
13602581	136	2x58	27	312	1547	100	278	1478	9.3	58	
13604181	136	4x18	28	622	622	100	578	578	6.3	44	
13604361	136	4x36	28	622	1247	100	578	1178	11.3	89	

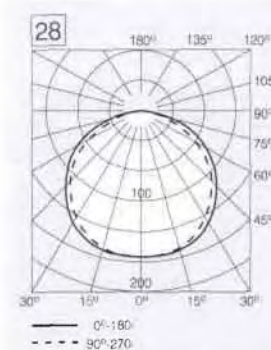

136 - 4x18				Flux CODE 44 76 97 100 59															
Index SPACE K	CIE DDR	CIE RCS	REFLECTIONS	873	871	773	771	753	751	731	711	551	531	511	331	000			
0.60	285	5	36	33	35	33	27	26	21	18	25	21	18	21	17				
0.80	367	5	43	39	41	38	33	31	27	23	30	26	23	26	22				
1.00	440	5	48	43	46	42	38	36	31	28	35	31	27	30	26				
1.25	513	5	52	46	49	45	43	40	36	32	39	35	32	34	30				
1.50	572	5	56	49	54	48	47	43	39	36	42	38	35	38	34				
2.00	664	5	61	53	58	52	53	48	44	42	46	44	41	43	39				
2.50	726	3	64	55	62	54	57	51	48	45	50	47	45	46	43				
3.00	771	5	66	57	64	56	59	53	50	48	52	49	48	49	45				
4.00	827	5	69	59	67	58	63	56	54	52	54	53	51	52	49				
5.00	862	5	71	60	68	59	65	57	56	54	56	55	53	53	51				
10.00	936	4	74	62	72	61	70	65	60	59	59	59	58	57	55				

531 - H(3.00-0.85)m - F1*F2=0.75			
AREA A*B	NUMBER OF LIGHTS REFLECTION		
	120 lx	250 lx	500 lx
10m ²	1.0	2.1	4.2
20m ²	1.7	3.5	7.0
30m ²	2.3	4.7	9.5
50m ²	3.3	6.9	13.9
70m ²	4.4	9.1	18.2
100m ²	6.1	12.7	25.3
150m ²	8.7	18.2	36.4



137 4x18W

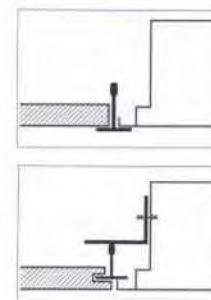
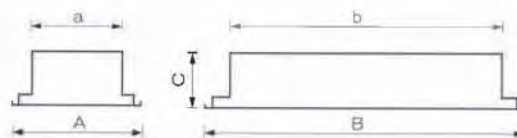

A white colour pickled steel sheet housing and frame IP54 protection by request. Plate of polymethacrylate - DIAMOND Application: laboratories, garages, dusty areas.

Ohišje in okvir iz dekapirane jeklene pločevine bele barve. Po naročilu v zaščiti IP54. Polimetakrilatna plošča - PRIZMATIČNA. Uporaba: laboratoriji, garaže, prašni prostori.

Корпус и рама из декапированной листовой стали белого цвета. По заказу в защите ИП54. Полиметакрилатная плита - ПРИЗМАТИЧЕСКАЯ. Применение: лаборатории, гаражи, пыльные помещения.

Kućište i okvir iz dekapiranog čeličnog lima bijele boje. Po narudžbi u zaštiti IP54. Polimetakrilatna ploča - PRIZMATIČNA. Upotreba: laboratoriji, garaže, zaprašene prostori.

Code	Art.	W	Photo data	A	B	C	a	b	kg	dm ³	Price
13702181	137	2x18	11	312	622	100	278	578	3.4	23	
13702361	137	2x36	11	312	1247	100	278	1178	6.6	47	
13702581	137	2x58	11	312	1547	100	278	1478	9.3	58	
13704181	137	4x18	12	622	622	100	578	578	6.3	44	
13704361	137	4x36	12	622	1247	100	578	1178	11.3	89	

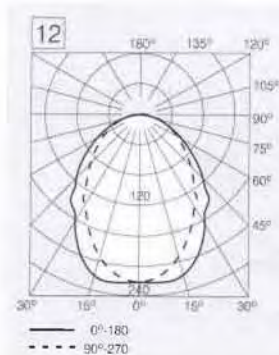

137 - 4x18		Flux CODE 52 82 98 100 66														
Index SPACE K	CIE DOR	CIE RCS	REFLECTIONS													
			873	871	773	771	753	751	731	711	551	531	511	331	000	
0.60	345	4	43	.40	.42	39	33	.32	.27	.24	31	27	.24	27	23	
0.80	429	4	50	.46	.49	45	40	.38	.33	.30	37	.33	.30	32	28	
1.00	502	4	56	50	54	49	46	43	38	35	42	38	35	37	33	
1.25	573	4	61	54	57	53	51	47	43	40	46	42	39	42	38	
1.50	628	4	64	57	62	56	55	51	47	44	49	46	43	45	41	
2.00	714	4	70	61	67	60	61	56	52	50	54	51	49	51	47	
2.50	770	3	73	63	71	62	65	59	56	53	57	55	53	54	51	
3.00	810	4	75	65	73	64	68	61	58	56	59	57	56	56	53	
4.00	858	4	78	66	75	66	72	63	62	60	62	60	59	59	56	
5.00	887	3	80	67	77	67	74	65	63	62	64	62	61	61	58	
10.00	947	3	83	70	80	69	79	73	67	66	67	66	65	65	62	

AREA A*B	NUMBER OF LIGHTS REFLECTION		
	120 lx	250 lx	500 lx
10m ²	0.8	1.7	3.4
20m ²	1.4	2.9	5.8
30m ²	1.9	3.9	7.9
50m ²	2.8	5.9	11.8
70m ²	3.7	7.8	15.5
100m ²	5.2	10.9	21.8
150m ²	7.6	15.8	31.5



141 1x36W

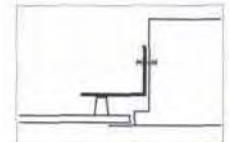
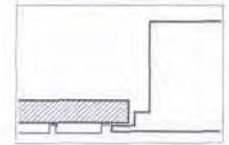
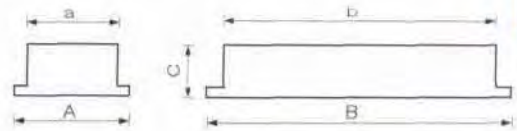
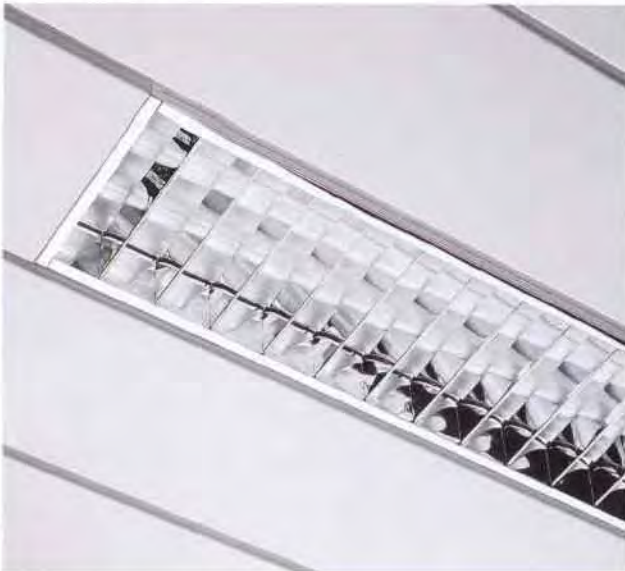

200
IP20
DARK LIGHT 50°

A white colour pickled steel sheet housing. The longitudinal and transverse highly polished parabolic optical grid of 99.99% aluminium allows excellent distribution of light (50...200 cd/m²). To be built into false ceiling with straight staves of the width of 200mm. Application: banks, insurance company offices, offices with video terminals, drawing offices...

Корпус из декapиpованной цвeтoвoй cтaли бeлoгo цвeтa. Пpoдoлbный и пoпepeчный блacтaнный пapабoличecкий paстp из 99.99% aлюминия ocyщecтвляeт ocoбeннoe paспpeдeлeниe cвeтa (50...200 cd/m²). Bcтpойкa в cпyщeннe пoтoлкe c pавными плacтикaми ширинoй 200мм. Пpимeнeниe: бaнки, cтpaxoвнe aгeнтcтвa, oфиcы c видeo тepминaлaми, пpoeктныe бypo...

Ohišje iz dekapirane jeklene pločevine bele barve. Vzdolžni in prečni visoko sijajni parabolični raster iz 99.99% aluminija omogoča izredno porazdelitev svetlobe (50...200 cd/m²). Vgradjnja v spuščene stropove z ravnimi lamelami širine 200mm. Uporaba: banke, zavarovalnice, pisarne z video terminali, projektivni biroji...

Kućište iz dekapiranog čeličnog lima bijele boje. Uzdužni i poprečni visoko sjajni parabolični raster iz 99.99% aluminija omogućava izvanrednu disperziju svjetlosti (50...200 cd/m²). Ugradjivanje u spuštene stropove sa ravnim lamelama širine 200mm. Upotreba: banke, osiguravajući zavodi, kancelarije s video terminalima, projekt biroji...

Code	Art.	W	Photo data	A	B	C	a	b	kg	dm ³	Price
14101181	141	1x18	13	200	650	90	170	625	2.9	13	
14101361	141	1x36	13	200	1260	90	170	1245	4.1	25	
14101581	141	1x58	13	200	1560	90	170	1545	6.2	31	

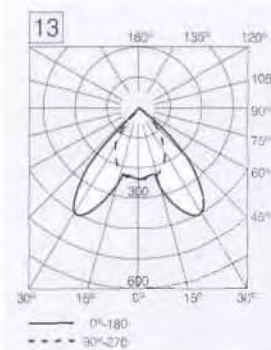

141 - 1x36			Flux CODE 83 100 100 100 61												
Index SPACE K	CIE DDR	CIE RCS	REFLECTIONS												
			873	871	773	771	753	751	731	711	651	631	511	331	000
0.60	580	-	.51	.47	.50	.46	.43	.42	.39	.36	.41	.38	.36	.38	.36
0.80	.655	-	.56	.51	.55	.50	.49	.46	.43	.41	.46	.43	.41	.43	.40
1.00	.720	-	.61	.54	.59	.54	.54	.50	.47	.46	.49	.47	.45	.47	.44
1.25	.775	-	.64	.57	.61	.56	.58	.53	.51	.49	.52	.50	.49	.50	.47
1.50	.813	-	.67	.59	.65	.58	.60	.55	.53	.52	.55	.53	.51	.52	.50
2.00	.871	-	.70	.61	.68	.61	.65	.59	.57	.56	.58	.56	.55	.56	.53
2.50	.906	-	.73	.63	.71	.62	.67	.60	.59	.58	.59	.58	.57	.58	.55
3.00	.929	-	.74	.64	.72	.63	.69	.62	.61	.60	.61	.60	.59	.59	.57
4.00	.950	-	.76	.64	.73	.64	.71	.63	.62	.61	.62	.61	.60	.60	.58
5.00	.961	-	.77	.65	.74	.64	.72	.63	.63	.62	.62	.62	.61	.61	.59
10.00	.982	-	.79	.66	.76	.65	.75	.69	.64	.64	.63	.63	.63	.62	.60

531 - H(3.00-0.85)m - F1*F2=0.75			
AREA A*B	NUMBER OF LIGHTS REFLECTION		
	120 lx	250 lx	500 lx
10m ²	1.0	2.2	4.3
20m ²	1.9	3.9	7.9
30m ²	2.7	5.6	11.1
50m ²	4.2	8.7	17.5
70m ²	5.7	11.8	23.6
100m ²	8.1	16.8	33.6
150m ²	11.9	24.7	49.4



142 1x36W

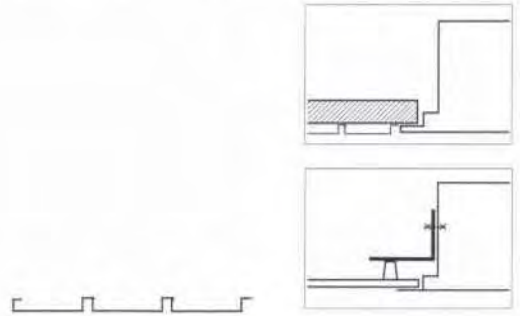
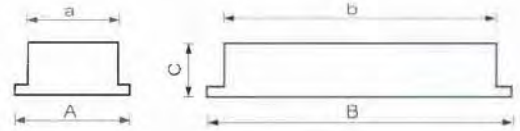
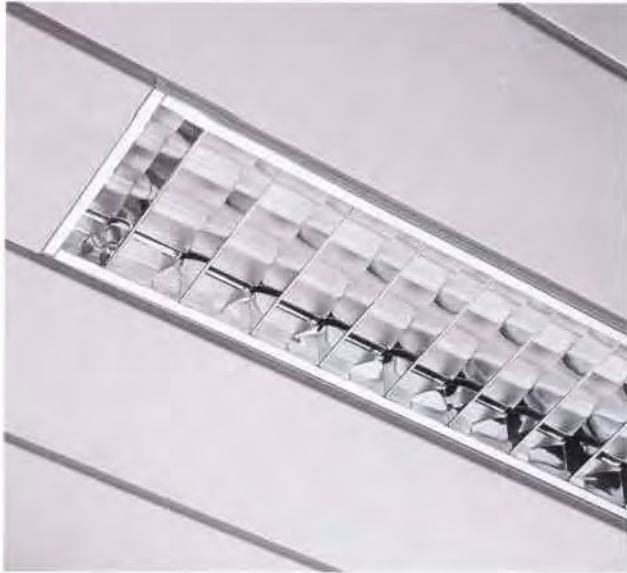

200
IP20

A white colour pickled steel sheet housing. The longitudinal and transverse polished parabolic optical grid of 99.90% aluminium allows very good distribution of light (60...200 cd/m²). To be built into false ceiling with straight staves of the width of 200mm. Application: banks, insurance company offices, offices with video terminals, shopping centres...

Ohišje iz dekapirane jeklene pločevine bele barve. Vzdolžni in prečni sijajni parabolični raster iz 99.90% aluminija omogoča zelo dobro porazdelitev svetlobe (60...200 cd/m²). Vgradnja v spuščene stropove z ravnimi lamelami širine 200mm. Uporaba: banke, zavarovalnice, pisarne z video terminali, trgovski centri...

Корпус из декапированной листовой стали белого цвета. Продольный и поперечный подлубстятый параболический растр из 99.90% алюминия осуществляет особенно хорошее распределение света (60...200цд/м²). Встройка в спущенные потолки с ровными пластинками шириной 200мм. Применение: банки, страховые агентства, офисы с видео терминалами, торговые центры...

Kućište iz dekapiranog čeličnog lima bijele boje. Uzdužni i poprečni sjajni parabolični raster iz 99.90% aluminija omogućava vrlo dobru disperziju svjetlosti (60...200 cd/m²). Ugradjivanje u spuštene stropove sa ravnim lamelama širine 200mm. Upotreba: banke, osiguravajući zavodi, kancelarije s video terminalima, trgovački centri...

Code	Art	W	Photo data	A	B	C	a	b	kg	dm ³	Price
14201181	142	1x18	14	200	650	90	170	625	2.6	13	
14201361	142	1x36	14	200	1260	90	170	1245	4.0	25	
14201581	142	1x58	14	200	1560	90	170	1545	6.0	31	

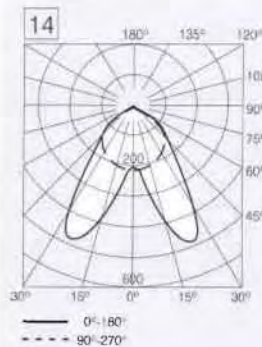

142 - 1x36		Flux CODE 88 100 100 100 57														
Index SPACE K	CIE DDR	CIE RCS	REFLECTIONS													
0.60	628	-	49	45	48	44	42	41	38	36	40	38	36	38	36	
0.80	694	-	53	48	52	48	47	44	42	40	44	42	40	41	39	
1.00	753	-	57	51	56	51	51	48	45	44	47	45	44	45	43	
1.25	801	-	60	53	58	53	54	50	48	47	50	48	46	47	45	
1.50	835	-	62	55	61	54	57	52	50	49	51	50	48	49	47	
2.00	889	-	66	57	64	56	60	55	53	52	54	53	52	52	50	
2.50	921	-	67	58	66	58	63	56	55	54	55	54	54	54	52	
3.00	944	-	69	59	67	58	64	57	57	56	56	56	55	55	53	
4.00	963	-	70	60	68	59	66	58	58	57	57	57	56	56	54	
5.00	973	-	71	60	69	60	67	59	58	58	58	57	57	57	55	
10.00	993	-	73	61	70	60	70	64	60	60	59	59	59	58	56	

531 - H(3.00-0.85)m - F1*F2=0.75			
AREA A*B	NUMBER OF LIGHTS REFLECTION		
	120 lx	250 lx	500 lx
10m ²	1.1	2.3	4.5
20m ²	2.0	4.2	8.3
30m ²	2.8	5.9	11.8
50m ²	4.5	9.3	18.7
70m ²	6.1	12.7	25.3
100m ²	8.6	18.0	35.9
150m ²	12.7	26.5	52.9



144 1x36W

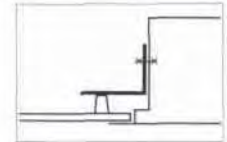
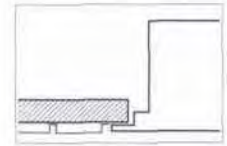
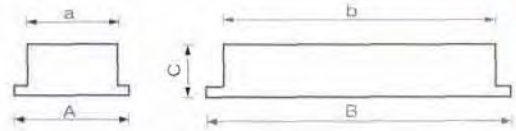

A white colour pickled steel sheet housing. The longitudinal V optical grid and fluted transverse blades of 99.85% aluminium allow good distribution of light. To be built into false ceilings with straight staves of the width of 200mm. Application: offices, shopping centres, banks, car shows...

Ohišje iz dekapirane jeklene pločevine bele barve. Vzdolžni V raster iz 99.85% aluminija in prečne narebrne lamele omogočajo dobro porazdelitev svetlobe. Vgradnja v spuščene stropove z ravnimi lamelami širine 200mm. Uporaba: pisarne, trgovski centri, banke, avto saloni...

Корпус из декапированной листової стали белог цвета. Продольный V raster из 99.85% алюминия, поперечная ребристая пластинка, осуществляют хорошее распределение света. Встроїта в спущенные потолки с ровными пластинками шириной 200мм. Применение: офисы, торговые центры, банки, автомобильные салоны...

Kućište iz poprečne čeličnog lima bijele boje. Uzdolžni V raster iz 99.85% aluminija i poprečne narebrne lamele omogućavaju dobru disperziju svjetlosti. Ugradjivanje u spuštene stropove s ravnim lamelama širine 200mm. Upotreba: kancelarije, trgovački centri, banke, auto saloni...

Code	Art.	W	Photo data	A	B	C	a	b	kg	dm ³	Price
14401181	144	1x18	07	200	650	90	170	625	2.6	13	
14401361	144	1x36	07	200	1260	90	170	1245	4.0	25	
14401581	144	1x58	07	200	1560	90	170	1545	6.0	31	

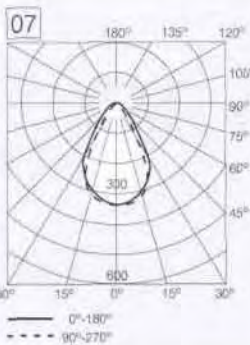





144 - 1x36		Flux CODE 65 95 100 100 57														
Index	CIE DDR	CIE RCS	REFLECTIONS													
SPACE K			873	871	773	771	753	751	731	711	551	531	511	331	000	
0.60	429	3	41	38	40	37	33	32	28	26	31	28	26	28	25	
0.80	524	2	47	43	46	42	40	37	34	31	37	33	31	33	30	
1.00	602	2	52	47	51	46	45	42	38	36	41	38	36	38	34	
1.25	673	2	56	50	54	49	49	45	42	40	45	42	40	41	38	
1.50	723	2	59	52	57	51	52	48	45	43	47	45	43	44	41	
2.00	799	2	63	55	61	54	57	52	50	48	51	49	47	48	46	
2.50	843	2	66	57	64	56	60	54	52	51	53	51	50	51	48	
3.00	874	2	67	58	65	57	62	55	54	53	54	53	52	52	50	
4.00	905	2	69	59	67	58	65	57	56	55	56	55	54	54	52	
5.00	922	2	70	60	68	59	66	58	57	56	57	56	55	55	53	
10.00	956	2	73	61	70	60	69	64	59	58	58	58	57	57	55	

531-H(3.00-0.85)m-F1*F2=0.75			
AREA A*B	NUMBER OF LIGHTS REFLECTION		
	120 lx	250 lx	500 lx
10m ²	1.3	2.7	5.4
20m ²	2.3	4.7	9.5
30m ²	3.2	6.6	13.2
50m ²	4.8	10.0	20.0
70m ²	6.5	13.6	27.2
100m ²	8.7	18.1	36.1
150m ²	13.0	27.0	54.5

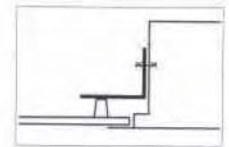
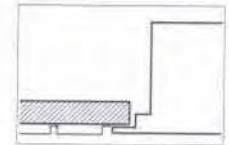
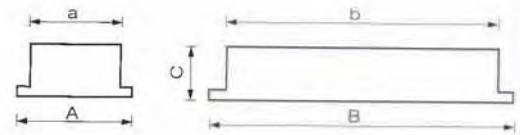

145 1x36W



200
IP20



A white colour pickled steel sheet housing. The longitudinal V optical grid and transverse blades of white colour allow good efficiency of lamp. To be built into false ceilings with straight staves of the width of 200 mm. Application: offices, shops.

Ohišje iz dekapirane jeklene pločevine bele barve. Vzdolžni V raster in prečne lamele bele barve omogočajo dober izkoristek svetilke. Vgrajnja v spuščene strope z ravnimi lamelami širine 200 mm. Uporaba: pisarne, trgovine.

Корпус из декапированной листовой стали белого цвета. Продольный V raster и поперечная пластинка белого цвета осуществляют хорошую эксплуатацию светильника. Встройка в спущенные потолки с ровными пластинками шириной 200мм. Применение: офисы, магазины...

Kućište iz dekapiranog čeličnog lima bijele boje. Uzdužni V raster i poprečne lamele bijele boje omogućavaju dobru iskorštenost svjetiljke. Ugradjivanje u spuštene stropove s ravnim lamelama širine 200 mm. Upotreba: kancelarije, trgovine...

Code	Art	W	Photo data	A	B	C	a	b	kg	dm ³	Price
14201181	145	1x18	09	200	650	90	170	625	2.6	13	
14201361	145	1x36	09	200	1260	90	170	1245	4.0	25	
14201581	145	1x58	09	200	1560	90	170	1545	6.0	31	

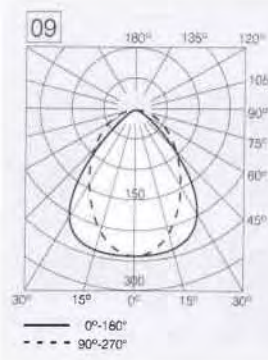

145 - 1x36			Flux CODE 70 100 100 100 42																						
Index SPACE K	CIE DDR	CIE RCS	REFLECTIONS																						
			873	871	773	771	753	751	731	711	551	531	511	331	000										
0.60	462	2	31	29	30	28	25	24	22	20	24	22	20	22	19										
0.80	561	2	36	32	35	32	30	29	26	24	28	26	24	26	23										
1.00	640	2	39	35	38	35	34	32	30	28	31	29	28	29	27										
1.25	711	1	42	37	40	37	37	34	32	31	34	32	31	32	30										
1.50	759	1	44	39	43	38	39	36	34	33	36	34	33	34	32										
2.00	829	1	47	41	46	40	43	39	37	36	38	37	36	36	35										
2.50	868	1	49	42	47	42	45	40	39	38	39	38	38	38	36										
3.00	894	1	50	43	48	42	46	41	40	39	40	40	39	39	37										
4.00	918	1	51	43	49	43	48	42	41	41	41	41	40	40	38										
5.00	930	1	52	44	50	43	48	43	42	41	42	41	41	40	39										
10.00	954	2	53	44	51	44	50	46	43	43	43	42	42	41	40										

531 - H(3.00-0.85)m - F1*F2=0.75			
AREA A*B	NUMBER OF LIGHTS REFLECTION		
	120 lx	250 lx	500 lx
10m ²	1.7	3.5	7.0
20m ²	3.0	6.2	12.4
30m ²	4.4	9.2	16.4
50m ²	6.4	13.3	26.6
70m ²	9.3	18.6	36.1
100m ²	12.4	25.8	51.6
150m ²	17.6	36.6	73.3



146 1x36W

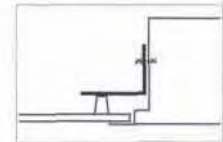
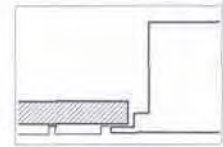
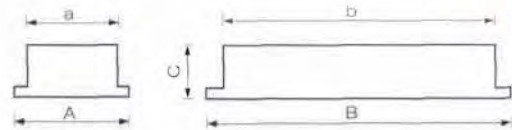

200 IP40

A white colour pickled steel sheet housing and frame. IP54 protection by request. Plate of polymethacrylate - OPAL. To be built into false ceilings with straight staves of the width of 200 mm. Application: laboratories, garages, dusty areas...

Ohišje in okvir iz dekapirane jeklene pločevine bele barve. Po naročilu v zaščiti IP54. Polimetakrilatna plošča - OPAL. Vgradnja v spuščene stropove z ravnimi lamelami širine 200 mm. Uporaba: laboratoriji, garaže, prašni prostori...

Корпус и рама из декапированной листовой стали белого цвета. По заказу в защите IP54. Полиметакрилатная плита - ОПАЛ. Встройка в спущенные подвесы с ровными пластинами шириной 200 мм. Применение: лаборатории, гаражи, пыльные помещения...

Kućište i okvir iz dekapiranog čeličnog lima bijele boje. Po narudžbi u zaštiti IP54. Polimetakrilatna ploča - OPAL. Ugradjivanje u spuštene stropove s ravnim lamelama širine 200 mm. Upotreba: laboratoriji, garaže, zaprašene prostorije...

Code	Art.	W	Photo data	A	B	C	a	b	kg	dm ³	Price
14201181	146	1x18	27	200	650	90	170	625	2.6	13	
14201361	146	1x36	27	200	1260	90	170	1245	4.0	25	
14201581	146	1x58	27	200	1560	90	170	1545	6.0	31	

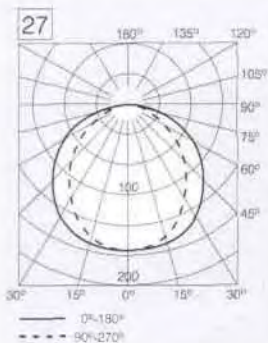



146 - 1x36		Flux CODE 45 76 96 100 57													
Index SPACE K	CIE DDR	CIE RCS	REFLECTIONS												
			873	871	773	771	753	751	731	711	551	531	511	331	000
0.60	295	5	35	32	34	32	26	25	21	18	24	21	18	20	17
0.80	376	5	41	37	40	36	32	30	26	23	29	26	23	25	21
1.00	448	5	46	41	44	40	37	34	30	27	34	30	27	29	25
1.25	520	5	50	45	47	44	41	38	34	31	37	34	31	33	29
1.50	577	5	53	47	52	46	45	41	38	35	40	37	34	36	33
2.00	668	5	58	51	56	50	51	46	43	40	45	42	40	41	38
2.50	730	3	61	53	59	52	54	49	46	44	48	45	43	44	41
3.00	774	5	63	55	61	54	57	51	48	46	50	48	46	47	44
4.00	830	5	66	56	64	56	61	53	52	50	52	51	49	50	47
5.00	864	4	68	57	65	57	63	55	53	52	54	52	51	51	49
10.00	937	4	71	60	69	59	67	62	57	57	57	56	56	55	53

531 - H(3,00-0,85)m - F1*F2=0.75			
AREA A*B	NUMBER OF LIGHTS REFLECTION		
	120lx	250lx	500lx
10m ²	1.7	3.5	7.0
20m ²	2.8	5.9	11.7
30m ²	3.9	8.0	15.9
50m ²	5.6	11.6	23.2
70m ²	7.4	15.4	30.7
100m ²	10.5	22.0	43.9
150m ²	14.0	29.2	58.4

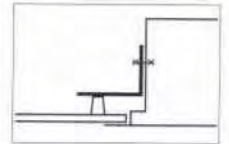
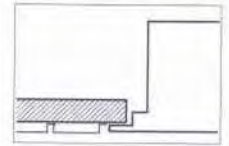
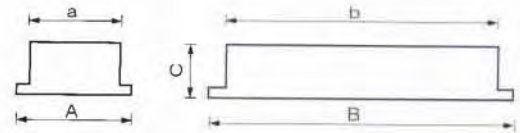

147 1x36W



200 IP40   

A white colour pickled steel sheet housing and frame. IP54 protection by request. Plate of polymethacrylate - DIAMOND. To be built into false ceilings with straight staves of the width of 200mm. Application: laboratories, garages, dusty areas...

Ohišje i okvir iz dekapirane jeklene pločevine bele barve. Po naročilu v zaščiti IP54. Polimetakrilatna plošča - PRIZMATIČNA. Vgradnja v spuščene stropove z ravnimi lamelami širine 200mm. Uporaba: laboratoriji, garaže, prašni prostori...

Корпус и рама из декапированной листовой стали белого цвета. По заказу в защите ИП54. Полиметакрилатная плитка - ПРИЗМАТИЧЕСКАЯ. Ветровка в спущенные потолки с ровными пластинками шириной 200мм. Применение: лаборатории, гаражи, пыльные помещения...

Kućište i okvir iz dekapiranog čeličnog lima bijele boje. Po narudžbi u zaščiti IP54. Polimetakrilatna ploča - PRIZMATIČNA. Ugradjivanje u spuščene stropove s ravnim lamelama širine 200mm. Upotreba: laboratoriji, garaže, zaprašene prostori...

Code	Art	W	Photo data	A	B	C	a	b	kg	dm ³	Price
14201181	147	1x18	11	200	650	90	170	625	2.6	13	
14201361	147	1x36	11	200	1260	90	170	1245	4.0	25	
14201581	147	1x58	11	200	1560	90	170	1545	6.0	31	

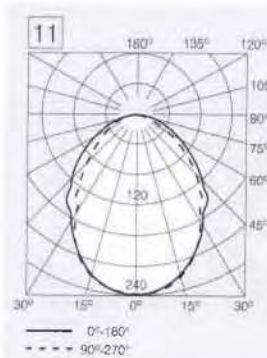

147 - 1x36		Flux CODE 51 81 98 100 58															
Index	SPACE K	CIE DDR	CIE RCS	REFLECTIONS													
				873	871	773	771	753	751	731	711	551	531	511	331	000	
0.60	339	5		38	35	37	34	29	28	24	21	27	23	21	23	20	
0.80	422	4		44	40	43	39	35	33	29	26	32	29	26	28	24	
1.00	495	4		49	44	47	43	40	37	33	30	36	33	30	32	29	
1.25	566	4		53	47	50	46	45	41	38	35	40	37	34	36	33	
1.50	622	4		56	50	54	49	48	44	41	38	43	40	38	40	36	
2.00	708	4		61	53	59	52	54	49	46	43	48	45	43	44	41	
2.50	766	3		64	55	62	54	57	51	49	47	50	48	46	47	44	
3.00	806	4		66	57	64	56	60	53	51	49	52	50	49	49	47	
4.00	856	4		69	58	66	58	63	56	54	52	54	53	52	52	50	
5.00	886	3		70	59	68	59	65	57	56	54	56	55	54	54	51	
10.00	948	3		73	61	71	61	69	64	59	58	59	58	57	57	55	

531 - H(3.00-0.85)m - F1*F2=0.75			
AREA A*B	NUMBER OF LIGHTS REFLECTION		
	120lx	250lx	500lx
10m ²	1.5	3.2	6.3
20m ²	2.6	5.4	10.7
30m ²	3.6	7.2	14.1
50m ²	5.2	10.8	21.7
70m ²	6.9	14.4	28.8
100m ²	10.2	20.1	40.0
150m ²	13.9	28.1	56.0



151 2x36W

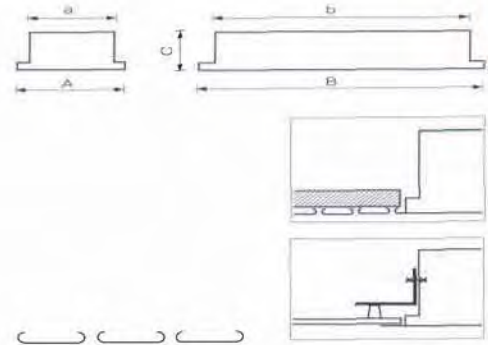

184 IP20 DARK LIGHT 90°

A white colour pickled steel sheet housing. The longitudinal and transverse highly polished parabolic optical grid of 99.99% aluminium allows excellent distribution of light (50...200 cd/m²). To be built into false ceilings with rounded staves of the width of 184mm. Application: banks, insurance company offices, offices with video terminals, drawing offices...

Ohišje iz dekapirane jeklene pločevine bele barve. Vzdolžni in prečni visoko sjajni parabolični raster iz 99.99% aluminija omogoča izredno porazdelitev svetlobe (50...200 cd/m²). Vgradnja v spuščene stropove z zaokroženimi lamelami širine 184mm. Uporaba: banke, zavarovalnice, pisarne z video terminali, projektivni biroji...

Корпус из декапированной листово́й стали белог цвета. Продольный и поперечный блестящий параболический решет из 99.99% алюминия осуществляет отличное распределение света (50...200 cd/m²). Встройка в спущенные потолки с округлёнными пластинами шириной 184мм. Применение: банки, страховые агентства, офисы с видео терминалами, проектные бюро...

Kućište iz dekapiranog čeličnog lima bijele boje. Uzdužni i poprečni visoko sjajni parabolični raster iz 99.99% aluminija omogućava izvanrečnu disperziju svjetlosti (50...200 cd/m²). Ugradjivanje u spuštene stropove s zaokroženim lamelama širine 184mm. Upotreba: banke, osiguravajući zavodi, kancelarije s video terminalima, projekt biroji...

Code	Art	W	Photo data	A	B	C	a	b	kg	dm ³	Price
15101181	151	1x18	18	184	664	95	160	620	3.0	14	
15101361	151	1x36	18	184	1270	95	160	1230	4.4	27	
15101581	151	1x58	18	184	1570	95	160	1530	6.2	33	
15102181	151	2x18	18	284	664	95	260	620	3.3	21	
15102361	151	2x36	18	284	1270	95	260	1230	6.1	40	
15102581	151	2x58	18	284	1570	95	260	1530	8.6	50	

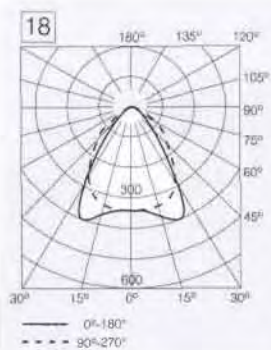

151 - 2x36		Flux CODE 83 100 100 100 61														
Index	SPACE K	CIE DDR	CIE RCS	REFLECTIONS												
0.60	580	-	-	873	871	773	771	753	751	731	711	551	531	511	331	000
0.80	655	-	-	51	47	50	46	43	42	39	36	41	38	36	38	36
1.00	720	-	-	61	54	59	54	54	50	47	46	49	47	45	47	44
1.25	775	-	-	64	57	61	56	58	53	51	49	52	50	49	50	47
1.50	813	-	-	67	59	65	58	60	55	53	52	55	53	51	52	50
2.00	871	-	-	70	61	68	61	65	59	57	56	58	56	55	56	53
2.50	906	-	-	73	63	71	62	67	60	59	58	59	58	57	58	55
3.00	929	-	-	74	64	72	63	69	62	61	60	61	60	59	59	55
4.00	950	-	-	76	64	73	64	71	63	62	61	62	61	60	60	58
5.00	961	-	-	77	65	74	64	72	63	63	62	62	62	61	61	59
10.00	982	-	-	79	66	76	65	75	69	64	64	63	63	63	62	60

AREA A*B	NUMBER OF LIGHTS REFLECTION		
	120lx	250lx	500lx
10m ²	0.5	1.1	2.2
20m ²	0.9	2.0	3.9
30m ²	1.3	2.8	5.6
50m ²	2.1	4.4	8.7
70m ²	2.8	5.9	11.8
100m ²	4.0	8.4	16.8
150m ²	5.9	12.4	24.7



152 2x36W

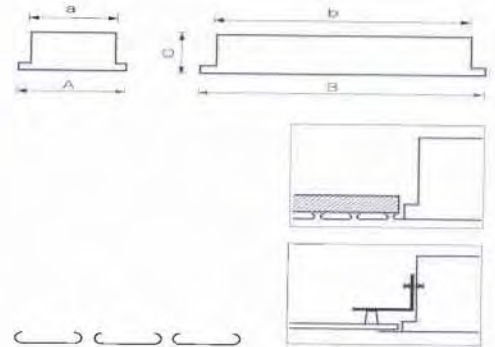

184 IP20    DARK LIGHT 60°

A white colour pickled steel sheet housing. The longitudinal and transverse polished parabolic optical grid of 99.90% aluminium allows very good distribution of light (60...200 cd/m²). To be built into false ceilings with rounded staves of the width of 184mm. Application: banks, insurance company offices, offices with video terminals, shopping centres...

Ohišje iz dekapirane jeklene pločevine bele barve. Vzdolžni in prečni sijajni parabolični raster iz 99.90% aluminija omogoča zelo dobro porazdelitev svetlobe (60...200 cd/m²). Vgradnja v spuščene stropove z zaokroženimi lamelami širine 184mm. Uporaba: banke, zavarovalnice, pisarne z video terminali, trgovski centri...

Корпус из декапированной листовой стали белого цвета. Продольный и поперечный полудвусторонний параболический raster из 99.90% алюминия осуществляет особенно хорошее распределение света (60...200 cd / м²). Встройка в спущенные потолки с округленными пластинками шириной 184мм. Применение: банки, страховые агентства, офисы с видео терминалами, торговые центры...

Kućište iz dekapiranog čeličnog lima bijele boje. Uzdužni i poprečni sjajni parabolični raster iz 99.90% aluminija omogućava vrlo dobru disperziju svjetlosti (60...200 cd/m²). Ugradjivanje u spuštene stropove s zaokruženim lamelama širine 184mm. Upotreba: banke, osiguravajući zavodi, kancelarije s video terminalima, trgovački centri...

Code	Art.	W	Photo data	A	B	C	a	b	kg	dm ³	Price
15201181	152	1x18	19	184	664	95	160	620	3.0	14	
15201361	152	1x36	19	184	1270	95	160	1230	4.4	27	
15201581	152	1x58	19	184	1570	95	160	1530	6.2	33	
15202181	152	2x18	19	284	664	95	260	620	3.3	21	
15202361	152	2x36	19	284	1270	95	260	1230	6.1	40	
15202581	152	2x58	19	284	1570	95	260	1530	8.6	50	

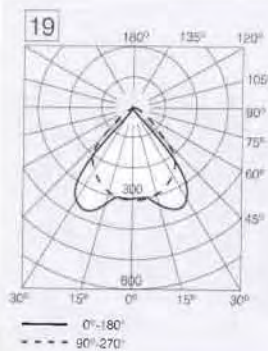

152 - 2x36		Flux CODE 88 100 100 100 57														
Index SPACE K	CIE DDR	CIE RCS	REFLECTIONS													
			873	871	773	771	753	751	731	711	551	531	511	331	000	
0.60	628	-	49	45	48	44	42	41	38	36	40	38	36	38	36	
0.80	694	-	53	48	52	48	47	44	42	40	44	42	40	41	39	
1.00	753	-	57	51	56	51	51	48	45	44	47	45	44	45	43	
1.25	801	-	60	53	58	53	54	50	48	47	50	48	46	47	45	
1.50	835	-	62	55	61	54	57	52	50	49	51	50	48	49	47	
2.00	889	-	66	57	64	56	60	55	53	52	54	53	52	52	50	
2.50	921	-	67	58	66	58	63	56	55	54	55	54	54	54	52	
3.00	944	-	69	59	67	58	64	57	57	56	56	56	55	55	53	
4.00	963	-	70	60	68	59	66	58	58	57	57	57	56	56	54	
5.00	973	-	71	60	69	60	67	59	58	58	58	57	57	57	55	
10.00	993	-	73	61	70	60	70	64	60	60	59	59	59	58	56	

531 - H(3.00-0.85)m - F1*F2=0.75			
AREA A*B	NUMBER OF LIGHTS REFLECTION		
	120 lx	250 lx	500 lx
10m ²	0.5	1.1	2.3
20m ²	1.0	2.1	4.2
30m ²	1.4	3.0	5.9
50m ²	2.2	4.7	9.3
70m ²	3.0	6.3	12.7
100m ²	4.3	9.0	18.0
150m ²	6.4	13.2	26.5



154 2x36W

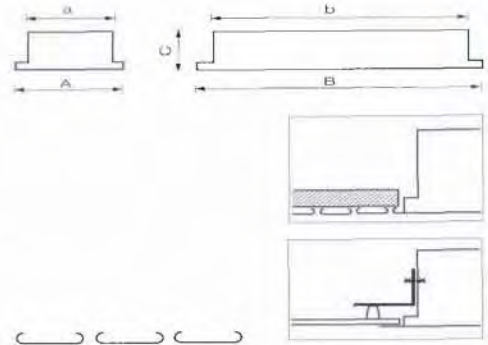

A white colour pickled steel sheet housing. The longitudinal V optical grid and fluted transverse blades of 99.85% aluminium allow good distribution of light. To be built into false ceilings with rounded staves of the width of 184mm. Application: offices, shopping centres, banks, car shows...

Ohišje iz dekapirane jeklene pločevine bele barve. Vzdolžni V raster iz 99.85% aluminija in prečne narebrne lamele omogočajo dobro porazdelitev svetlobe. Vgradnja v spuščene stropove z zaokroženimi lamelami širine 184mm. Uporaba: pisarne, trgovski centri, banke, avto saloni...

Корпус из декапированной листовой стали белого цвета. Продольный V raster из 99.85% алюминия, поперечная ребристая пластинка, обеспечивают хорошее распределение света. Встраивается в спущенные потолки с округлыми пластинками шириной 184мм. Применение: офисы, торговые центры, банки, автомобильные салоны...

Kućište iz dekapiranog čeličnog lima bijele boje. Uzdužni V raster iz 99.85% aluminija i poprečne narebrne lamele omogućavaju dobru disperziju svjetlosti. Ugradjivanje u spuštene stropove s zaokruženim lamelama širine 184mm. Upotreba: kancelarije, trgovački centri, banke, auto saloni...

Code	Art	W	Photo data	A	B	C	a	b	kg	dm ³	Price
15401181	154	1x18	07	184	664	95	160	620	2.6	13	
15401361	154	1x36	07	184	1270	95	160	1230	4.1	24	
15401581	154	1x58	07	184	1570	95	160	1530	5.8	30	
15402181	154	2x18	07	284	664	95	260	620	3.0	19	
15402361	154	2x36	07	284	1270	95	260	1230	5.7	37	
15402581	154	2x58	07	284	1570	95	260	1530	8.2	46	

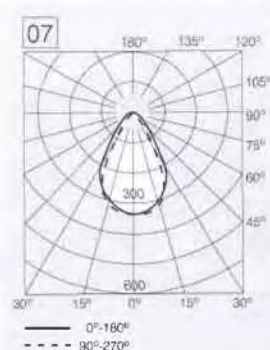

154 - 2x36		Flux CODE 65 95 100 100 57														
Index SPACE K	CIE DDR	CIE RCS	REFLECTIONS													
			873	871	773	771	753	751	731	711	551	531	511	331	000	
0.60	.429	3	41	38	40	37	33	32	28	26	31	28	26	28	25	
0.80	524	3	47	43	46	42	40	37	34	31	37	33	31	33	30	
1.00	602	2	52	47	51	46	45	42	38	36	41	38	36	38	34	
1.25	673	2	56	50	54	49	49	45	42	40	45	42	40	41	38	
1.50	723	2	59	52	57	51	52	48	45	43	47	45	43	44	41	
2.00	799	2	63	55	61	54	57	52	50	48	51	49	47	48	46	
2.50	843	2	66	57	64	56	60	54	52	51	53	51	50	51	48	
3.00	874	2	67	58	65	57	62	55	54	53	54	53	52	52	50	
4.00	905	2	69	59	67	58	65	57	56	55	56	55	54	54	52	
5.00	922	2	70	60	68	59	66	58	57	56	57	56	55	55	53	
10.00	956	2	73	61	70	60	69	64	59	58	58	58	57	57	55	

531-H(3.00-0.85)m·F1*F2=0.75			
AREA A*B	NUMBER OF LIGHTS REFLECTION		
	120lx	250lx	500lx
10m ²	0.7	1.4	2.7
20m ²	1.1	2.4	4.7
30m ²	1.6	3.3	6.5
50m ²	2.4	5.0	10.0
70m ²	3.2	6.7	13.4
100m ²	4.5	9.5	18.9
150m ²	6.6	13.8	27.7



155 2x36W

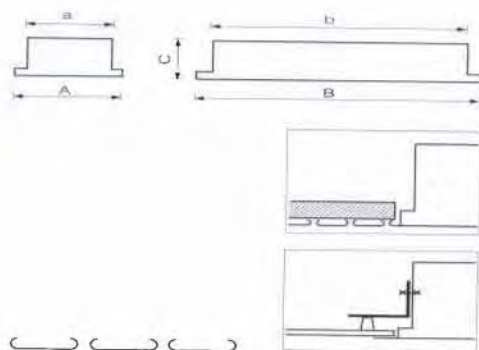

A white colour pickled steel sheet housing. The longitudinal V optical grid and transverse blades of white colour allow good efficiency of lamp. To be built into false ceilings with rounded staves of the width of 184mm. Application: offices, shops...

Ohišje iz dekapirane jeklene pločevine bele barve. Vzdolžni V raster in prečne lamele bele barve omogočajo dober izkoristek svetilke. Vgradnja v spuščene stropove z zaokroženimi lamelami širine 184mm. Uporaba: pisarne, trgovine...

Корпус из декапированной листовой стали белого цвета. Продольный V raster и поперечная пластинка белого цвета осуществляют хорошую эксплуатацию светильника. Встройка в спущенные потолки с округлёнными пластинками шириной 184мм. Применение: офисы, магазины...

Kućište iz dekapiranog čeličnog lima bijele boje. Uzdužni V raster i poprečne lamele bijele boje omogućavaju dobru iskoristenoost svjetiljke. Ugradjivanje u spuštene stropove s zaokruženim lamelama širine 184 mm. Upotreba: kancelarije, trgovine...

Code	Art.	W	Photo data	A	B	C	a	b	kg	dm ³	Price
15501181	155	1x18	09	184	664	95	160	620	2.6	13	
15501361	155	1x36	09	184	1270	95	160	1230	4.1	24	
15501581	155	1x58	09	184	1570	95	160	1530	5.8	30	
15502181	155	2x18	09	284	664	95	260	620	3.0	19	
15502361	155	2x36	09	284	1270	95	260	1230	5.7	37	
15502581	155	2x58	09	284	1570	95	260	1530	8.2	46	

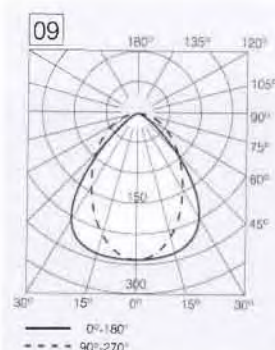

155 - 2x36				Flux CODE 70 100 100 100 42																					
Index	CIE	CIE	REFLECTIONS																						
SPACE K	DDR	RCS	873	871	773	771	753	751	731	711	551	531	511	331	000										
0.60	462	2	31	29	30	28	25	24	22	20	24	22	20	22	19										
0.80	561	2	36	32	35	32	30	29	26	24	28	26	24	26	23										
1.00	640	2	39	35	38	35	34	32	30	28	31	29	28	29	27										
1.25	711	1	42	37	40	37	37	34	32	31	34	32	31	32	30										
1.50	759	1	44	39	43	38	39	36	34	33	36	34	33	34	32										
2.00	829	1	47	41	46	40	43	39	37	36	38	37	36	36	35										
2.50	868	1	49	42	47	42	45	40	39	38	39	38	38	38	36										
3.00	894	1	50	43	48	42	46	41	40	39	40	40	39	39	37										
4.00	918	1	51	43	49	43	48	42	41	41	41	41	40	40	38										
5.00	930	1	52	44	50	43	48	43	42	41	42	41	41	40	39										
10.00	954	2	53	44	51	44	50	46	43	43	42	42	41	40											

531 - H(3 00-0.85)m - F1*F2=0.75			
AREA A*B	NUMBER OF LIGHTS REFLECTION		
	120 lx	250 lx	500 lx
10m ²	0.8	1.8	3.5
20m ²	1.5	3.1	6.2
30m ²	2.1	4.3	8.6
50m ²	3.2	6.6	13.3
70m ²	4.3	8.9	17.8
100m ²	6.1	12.7	25.3
150m ²	8.9	18.6	37.2



156 2x36W

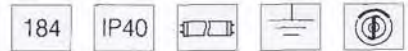
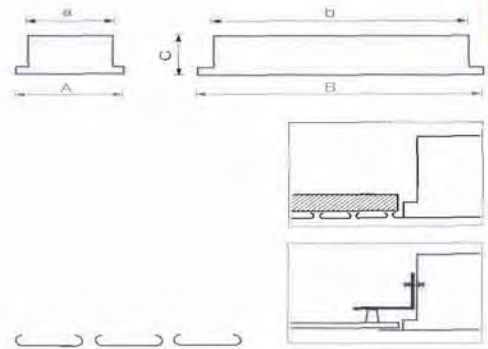

A white colour pickled steel sheet housing and frame. IP54 protection by request. Plate of polymethacrylate - OPAL. To be built into false ceilings with rounded staves of the width of 184mm. Application: laboratories, garages, dusty areas...

Ohišje in okvir iz dekapirane jeklene pločevine bele barve. Po naročilu v zaščiti IP54. Polimetakrilatna plošča - OPAL. Vgradnja v spuščene stropove z zaokroženimi lamelami širine 184 mm. Uporaba: laboratoriji, garaže, prašni prostori...

Корпус и рама из декапированной листової стали белого цвета. По заказу в защите ИП54. Полиметакрилатная плита-ОПАЛ. Встройка в спущенные потолки с округлёнными пластинками шириной 184мм. Применение: лаборатории, гаражи, пыльные помещения...

Kućište i okvir iz dekapiranog čeličnog lima bijele boje. Po narudžbi u zaštiti IP54. Polimetakrilatna ploča - OPAL. Ugradnja u spuštene stropove s zaokruženim lamelama širine 184 mm. Upotreba: laboratoriji, garaže, zaprašene prostorije...

Code	Art.	W	Photo data	A	B	C	a	b	kg	dm ³	Price
15601181	156	1x18	27	184	664	95	160	620	3.1	13	
15601361	156	1x36	27	184	1270	95	160	1230	4.9	24	
15601581	156	1x58	27	184	1570	95	160	1530	7.1	30	
15602181	156	2x18	27	284	664	95	260	620	3.3	19	
15602361	156	2x36	27	284	1270	95	260	1230	6.6	37	
15602581	156	2x58	27	284	1570	95	260	1530	9.3	46	

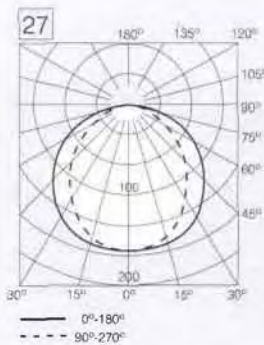

156 - 2x36		Flux CODE 44 76 97 100 59														
Index SPACE K	CIE DDR	CIE RCS	REFLECTIONS													
			873	871	773	771	753	751	731	711	551	531	511	331	000	
0.60	285	5	36	33	35	33	27	26	21	18	25	21	18	21	17	
0.80	367	5	43	39	41	38	33	31	27	23	30	26	23	26	22	
1.00	440	5	48	43	46	42	38	36	31	28	35	31	27	30	26	
1.25	513	5	52	46	49	45	43	40	36	32	39	35	32	34	30	
1.50	572	5	56	49	54	48	47	43	39	36	42	38	35	38	34	
2.00	664	5	61	53	58	52	53	48	44	42	46	44	41	43	39	
2.50	726	3	64	55	62	54	57	51	48	45	50	47	45	46	43	
3.00	771	5	66	57	64	56	59	53	50	48	52	49	48	49	45	
4.00	827	5	69	59	67	58	63	56	54	52	54	53	51	52	49	
5.00	862	5	71	60	68	59	65	57	56	54	56	55	53	53	51	
10.00	936	4	74	62	72	61	70	65	60	59	59	59	58	57	55	

AREA A*B	NUMBER OF LIGHTS REFLECTION		
	120 lx	250 lx	500 lx
10m ²	0.8	1.8	3.5
20m ²	1.4	2.9	5.9
30m ²	1.9	4.0	7.9
50m ²	2.8	5.8	11.6
70m ²	3.7	7.6	15.2
100m ²	5.1	10.6	21.2
150m ²	7.3	15.3	30.5



157 2x36W

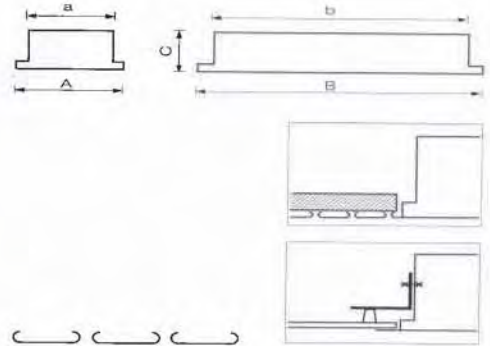

A white colour pickled steel sheet housing and frame. IP54 protection by request. Plate of polymethacrylate - DIAMOND. To be built into false ceilings with rounded staves of the width of 184mm. Application: laboratories, garages, dusty areas...

Ohišje in okvir iz dekapirane jeklene pločevine bele barve. Po naročilu v zaščiti IP54. Polimetakrilatna plošča - PRIZMATIČNA. Vgradnja v spuščene stropove z zaokroženimi lamelami širine 184mm. Uporaba: laboratoriji, garaže, prašni prostori...

Корпус и рама из декапированной листовой стали белого цвета. По заказу в защите ИП54. Полиметакрилатная плитка - ПРИЗМАТИЧЕСКАЯ. Встройка в спущенные потолки с округлёнными пластинками шириной 184мм. Применение: лаборатории, гаражи, пыльные помещения...

Kućište i okvir iz dekapiranog čeličnog lima bijele boje. Po narudžbi u zaštiti IP54. Polimetakrilatna ploča - PRIZMATIČNA. Ugradjivanje u spuštene stropove s zaokruženim lamelama širine 184 mm. Upotreba: laboratoriji, garaže, zaprašene prostorije...

Code	Art	W	Photo data	A	B	C	a	b	kg	dm ³	Price
15701181	157	1x18	11	184	664	95	160	620	3.1	13	
15701361	157	1x36	11	184	1270	95	160	1230	4.9	24	
15701581	157	1x58	11	184	1570	95	160	1530	7.1	30	
15702181	157	2x18	11	284	664	95	260	620	3.3	19	
15702361	157	2x36	11	284	1270	95	260	1230	6.6	37	
15702581	157	2x58	11	284	1570	95	260	1530	9.3	46	

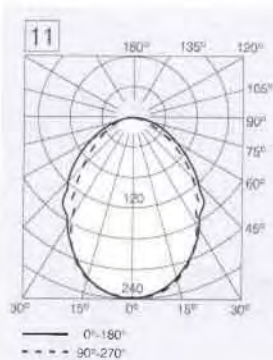

157 - 2x36		Flux CODE 51 81 98 100 58																
Index	CIE	CIE	REFLECTIONS															
SPACE K	DDR	RCS	873	871	773	771	753	751	731	711	551	531	511	331	000			
0.60	339	5	.38	.35	.37	.34	.29	.28	.24	.21	.27	.23	.21	.23	.20			
0.80	422	4	.44	.40	.43	.39	.35	.33	.29	.26	.32	.29	.26	.28	.24			
1.00	495	4	.49	.44	.47	.43	.40	.37	.33	.30	.36	.33	.30	.32	.29			
1.25	566	4	.53	.47	.50	.46	.45	.41	.38	.35	.40	.37	.34	.36	.33			
1.50	622	4	.56	.50	.54	.49	.48	.44	.41	.38	.43	.40	.38	.40	.36			
2.00	708	4	.61	.53	.59	.52	.54	.49	.46	.43	.48	.45	.43	.44	.41			
2.50	766	3	.64	.55	.62	.54	.57	.51	.49	.47	.50	.48	.46	.47	.44			
3.00	806	4	.66	.57	.64	.56	.60	.53	.51	.49	.52	.50	.49	.49	.47			
4.00	856	4	.69	.58	.66	.58	.63	.56	.54	.52	.54	.53	.52	.52	.50			
5.00	886	3	.70	.59	.68	.59	.65	.57	.56	.54	.56	.55	.54	.54	.51			
10.00	948	3	.73	.61	.71	.61	.69	.64	.59	.58	.59	.58	.57	.57	.55			

531 - H(3.00-0.85)m - F1*F2=0.75			
AREA A*B	NUMBER OF LIGHTS REFLECTION		
	120 lx	250 lx	500 lx
10m ²	0.8	1.6	3.2
20m ²	1.3	2.7	5.4
30m ²	1.7	3.6	7.3
50m ²	2.6	5.4	10.8
70m ²	3.4	7.2	14.3
100m ²	4.8	10.0	20.0
150m ²	7.0	14.5	29.0



211 2x36W

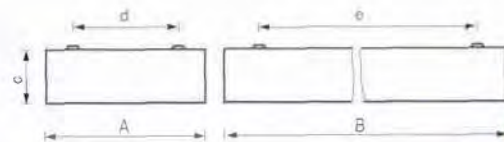

A white colour pickled steel sheet housing. The longitudinal and transverse highly polished parabolic optical grid of 99.99% aluminium allows excellent distribution of light (50..200 cd/m²). Application: banks, insurance company offices, offices with video terminals, drawing offices...

Ohišje iz dekapirane jeklene pločevine bele barve. Vzdolžni in prečni visoko sijajni parabolični raster iz 99.99% aluminija omogoča izredno porazdelitev svetlobe (50..200 cd/m²). Uporaba: banke, zavarovalnice, pisarne z video terminali, projektni biroji...

Корпус из декапированной листового сталя белого цвета. Продольный и поперечный блестящий параболический raster из 99.99% алюминия осуществляет особенное распределение света (50..200 cd/m²). Применение: банки, страховые агентства, офисы с видео терминалами, проектные бюро...

Kućište iz dekapiranog čeličnog lima bijele boje. Uzdužni i poprečni visoko sjajni parabolični raster iz 99.99% aluminija omogućava izvanrednu disperziju svetlosti (50..200 cd/m²). Upotreba: banke, osiguravajući zavodi, kancelarije s video terminalima, projekt biroji...

Code	Art.	W	Photo data	A	B	C	d	e	kg	dm ³	Price
21101181	211	1x18	01	185	640	100	150	450	3.9	17	
21101361	211	1x36	01	185	1250	100	150	930	6.2	33	
21101581	211	1x58	01	185	1550	100	150	1210	8.4	41	
21102181	211	2x18	01	285	640	100	230	450	4.6	24	
21102361	211	2x36	01	285	1250	100	230	930	7.5	47	
21102581	211	2x58	01	285	1550	100	230	1210	11.0	58	
21103181	211	3x18	02	600	650	100	510	450	8.1	46	
21103361	211	3x36	02	600	1250	100	510	930	12.7	89	
21104181	211	4x18	02	600	640	100	510	450	8.5	46	
21104361	211	4x36	02	600	1250	100	510	930	13.3	89	

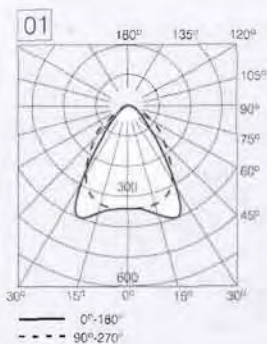

211 - 2x36		Flux CODE 83 100 100 100 61													
Index	CIE	CIE	REFLECTIONS												
SPACE K	DDR	RCS	873	871	773	771	753	751	731	711	551	531	511	331	000
0.60	580	-	51	47	50	46	43	42	39	36	41	38	36	38	36
0.80	655	-	56	51	55	50	49	46	43	41	46	43	41	43	40
1.00	720	-	61	54	59	54	54	50	47	46	49	47	45	47	44
1.25	775	-	64	57	61	56	58	53	51	49	52	50	49	50	47
1.50	813	-	67	59	65	58	60	55	53	52	55	53	51	52	50
2.00	871	-	70	61	68	61	65	59	57	56	58	56	55	56	53
2.50	906	-	73	63	71	62	67	60	59	58	59	58	57	58	55
3.00	929	-	74	64	72	63	69	62	61	60	61	60	59	59	57
4.00	950	-	76	64	73	64	71	63	62	61	62	61	60	60	58
5.00	961	-	77	65	74	64	72	63	63	62	62	62	61	61	59
10.00	982	-	79	66	76	65	75	69	64	64	63	63	63	62	60

531 - H(3 00-0.85)m - F1*F2=0.75			
AREA A*B	NUMBER OF LIGHTS REFLECTION		
	120lx	250lx	500lx
10m ²	0.5	1.1	2.1
20m ²	0.9	1.9	3.8
30m ²	1.3	2.7	5.4
50m ²	2.0	4.2	8.5
70m ²	2.8	5.7	11.5
100m ²	3.9	8.1	16.3
150m ²	5.8	12.0	24.0



212 2x36W

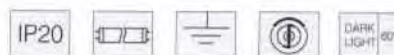
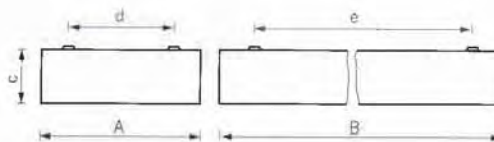

A white colour pickled steel sheet housing. The longitudinal and transverse polished parabolic optical grid of 99.90% aluminium allows very good distribution of light (60...200 cd/m²). Application: banks, insurance company offices, offices with video terminals, shopping centres...

Ohišje iz dekapirane jeklene pločevine bele barve. Vzdolžni in prečni sijajni parabolični raster iz 99.90% aluminija omogoča zelo dobro porazdelitev svetlobe (60...200 cd/m²). Uporaba: banke, zavarovalnice, pisarne z video terminali, trgovski centri...

Корпус из декапированной листовой стали белого цвета. Продольный и поперечный полубудеющийся параболический растр из 99.90% алюминия осуществляет особенно хорошее распределение света (60...200 лд/м²). Применение: банки, страховые агентства, офисы с видео терминалами, торговые центры...

Kućište iz dekapiranog čeličnog lima bijele boje. Uzdužni i poprečni sijajni parabolični raster iz 99.90% aluminija omogućava vrlo dobru disperziju svjetlosti (60...200 cd/m²). Upotreba: banke, osiguravajući zavodi, kancelarije s video terminalima, trgovački centri...

Code	Art.	W	Photo data	A	B	C	d	e	kg	dm ³	Price
21201181	212	1x18	03	185	640	100	150	450	3.7	17	
21201361	212	1x36	03	185	1250	100	150	930	6.0	33	
21201581	212	1x58	03	185	1550	100	150	1210	8.2	41	
21202181	212	2x18	03	285	640	100	230	450	4.4	24	
21202361	212	2x36	03	285	1250	100	230	930	7.3	47	
21202581	212	2x58	03	285	1550	100	230	1210	10.7	58	
21203181	212	3x18	04	600	650	100	510	450	7.7	46	
21203361	212	3x36	04	600	1250	100	510	930	12.7	89	
21204181	212	4x18	04	600	640	100	510	450	8.5	46	
21204361	212	4x36	04	600	1250	100	510	930	13.3	89	

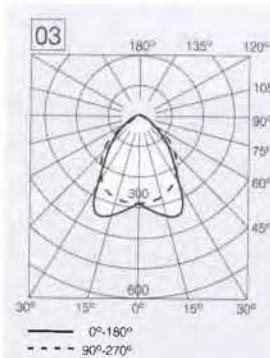

212 - 2x36		Flux CODE 90 100 100 100 57														
Index SPACE K	CIE DDR	CIE RCS	REFLECTIONS													
			873	871	773	771	753	751	731	711	551	531	511	331	000	
0.60	648	-	37	34	36	34	32	31	29	28	31	29	28	29	27	
0.80	710	-	40	37	40	36	36	34	32	31	33	32	31	32	32	
1.00	766	-	43	39	42	38	39	36	35	33	36	34	33	34	32	
1.25	812	-	45	40	43	40	41	38	37	35	37	36	35	36	34	
1.50	844	-	47	41	46	41	43	39	38	37	39	38	37	37	36	
2.00	896	-	49	43	48	42	45	41	40	39	41	40	39	39	38	
2.50	928	-	51	44	49	43	47	42	42	41	42	41	40	41	39	
3.00	950	-	52	44	50	44	48	43	43	42	42	42	41	41	40	
4.00	968	-	53	45	51	44	50	44	43	43	43	43	42	42	42	
5.00	978	-	53	45	52	45	51	44	44	44	44	43	43	43	41	
10.00	998	-	55	46	53	45	52	48	45	45	44	44	44	43	42	

AREA A*B	NUMBER OF LIGHTS REFLECTION		
	120 lx	250 lx	500 lx
10m ²	0.7	1.5	3.0
20m ²	1.3	2.7	5.5
30m ²	1.9	3.9	7.8
50m ²	3.0	6.2	12.2
70m ²	4.0	8.4	16.8
100m ²	5.7	11.9	23.9
150m ²	8.4	17.6	35.2



214 2x36W

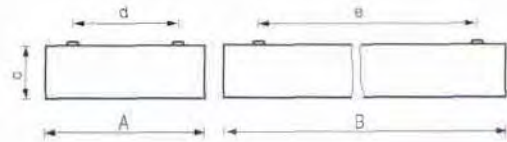

A white colour pickled steel sheet housing. The longitudinal V optical grid and fluted transverse blades of 99.85% aluminium allow good distribution of light. Application: offices, shopping centres, banks, car shows...

Ohišje iz dekapirane jeklene pločevine bele barve. Vzdolžni V raster iz 99.85% aluminija in prečne narebrne lamele omogočajo dobro porazdelitev svetlobe. Uporaba: pisarne, trgovski centri, banke, avto saloni...

Корпус из декапированной листового стали белого цвета. Продольный V raster из 99.85% алюминия, поперечная ребристая пластинка, осуществляют хорошее распределение света. Применение: офисы, торговые центры, банки, автомобильные салоны...

Kućište iz dekapiranog čeličnog lima bijele boje. Uzdužni V raster iz 99.85% aluminija i poprečne narebrne lamele omogućavaju dobru disperziju svjetlosti. Upotreba: kancelarije, trgovački centri, banke, auto saloni...

Code	Art.	W	Photo data	A	B	C	d	e	kg	dm ³	Price
21401181	214	1x18	07	175	640	75	100	500	3.6	10	
21401361	214	1x36	07	175	1250	75	100	930	5.6	20	
21401581	214	1x58	07	175	1550	75	100	1230	6.1	24	
21402181	214	2x18	07	285	640	75	200	500	4.1	17	
21402361	214	2x36	07	285	1250	75	200	930	7.2	32	
21402581	214	2x58	07	285	1550	75	200	1230	11.2	40	
21404181	214	4x18	08	600	640	75	510	500	6.7	34	
21404361	214	4x36	08	600	1250	75	510	930	13.8	66	

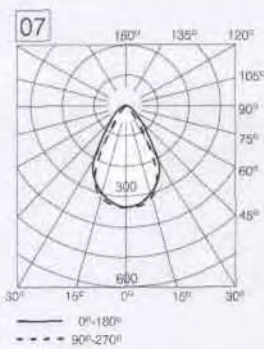

214 - 2x36		Flux CODE 65 95 100 100 57														
Index	CIE	CIE	REFLECTIONS													
SPACE K	DDR	RCS	873	871	773	771	753	751	731	711	551	531	511	331	000	
0.60	429	3	41	38	40	37	33	32	28	26	31	28	26	28	25	
0.80	524	3	47	43	46	42	40	37	34	31	37	33	31	33	30	
1.00	602	2	52	47	51	46	45	42	38	36	41	38	36	38	34	
1.25	673	2	56	50	54	49	49	45	42	40	45	42	40	41	38	
1.50	723	2	59	52	57	51	52	48	45	43	47	45	43	44	41	
2.00	799	2	63	55	61	54	57	52	50	48	51	49	47	48	46	
2.50	843	2	66	57	64	56	60	54	52	51	53	51	50	51	48	
3.00	874	2	67	58	65	57	62	55	54	53	54	53	52	52	50	
4.00	905	2	69	59	67	58	65	57	56	55	56	55	54	54	52	
5.00	922	2	70	60	68	59	66	58	57	56	57	56	55	55	53	
10.00	956	2	73	61	70	60	69	64	59	58	58	58	57	57	55	

531 - H(3 00-0 85)m - F1*F2=0,75			
AREA A*B	NUMBER OF LIGHTS REFLECTION		
	120 lx	250 lx	500 lx
10m ²	0.7	1.4	2.7
20m ²	1.1	2.4	4.7
30m ²	1.6	3.3	6.5
50m ²	2.4	5.0	10.0
70m ²	3.2	6.7	13.4
100m ²	4.5	9.5	18.9
150m ²	6.6	13.8	27.7



215 2x36W

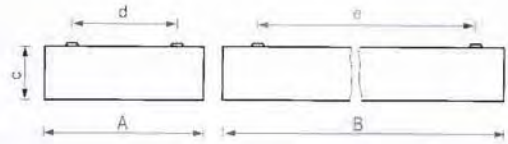

A white colour pickled steel sheet housing. The longitudinal V optical grid and transverse blades of white colour allow good efficiency of lamp. Application: offices, shops...

Ohišje iz dekapirane jeklene pločevine bele barve. Vzdolžni V raster in prečne lamele bele barve omogočajo dober izkoristek svetilke. Uporaba: pisarne, trgovine...

Корпус из декапированной листовой стали белого цвета. Продольный V raster и поперечная пластинка белого цвета осуществляют хорошую эксплуатацию светильника. Применение: офисы, магазины...

Kućište iz dekapiranog čeličnog lima bijele boje. Uzdužni V raster i poprečne lamele bijele boje omogućavaju dobru iskorisćenost svjetiljke. Upotreba: kancelarije, trgovine...

Code	Art.	W	Photo data	A	B	C	d	e	kg	dm ³	Price
21501181	215	1x18	09	175	640	75	100	500	3.6	10	
21501361	215	1x36	09	175	1250	75	100	930	5.6	20	
21501581	215	1x58	09	175	1550	75	100	1230	6.1	24	
21502181	215	2x18	09	285	640	75	200	500	4.1	17	
21502361	215	2x36	09	285	1250	75	200	930	7.2	32	
21502581	215	2x58	09	285	1550	75	200	1230	11.2	40	
21504181	215	4x18	10	600	640	75	510	500	6.7	34	
21504361	215	4x36	10	600	1250	75	510	930	13.8	66	

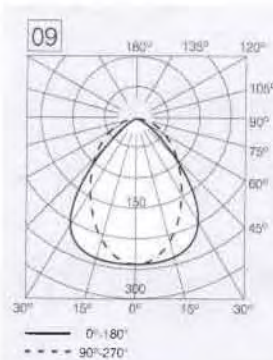

215 - 2x36			Flux CODE 70 100 100 100 42															
Index SPACE K	CIE DDR	CIE RCS	REFLECTIONS															
			873	871	773	771	753	751	731	711	551	531	511	331	000			
0.60	462	2	31	29	30	28	25	24	22	20	24	22	20	22	19			
0.80	561	2	36	32	35	32	30	29	26	24	28	26	24	26	23			
1.00	640	2	39	35	38	35	34	32	30	28	31	29	28	29	27			
1.25	711	1	42	37	40	37	37	34	32	31	34	32	31	32	30			
1.50	759	1	44	39	43	38	39	36	34	33	36	34	33	34	32			
2.00	829	1	47	41	46	40	43	39	37	36	38	37	36	36	35			
2.50	868	1	49	42	47	42	45	40	39	38	39	38	38	38	36			
3.00	894	1	50	43	48	42	46	41	40	39	40	40	39	39	37			
4.00	918	1	51	43	49	43	48	42	41	41	41	41	40	40	38			
5.00	930	1	52	44	50	43	48	43	42	41	42	41	41	40	39			
10.00	954	2	53	44	51	44	50	46	43	43	43	42	42	41	40			

531 - H(3.00-0.85)m - F1*F2=0.75			
AREA A*B	NUMBER OF LIGHTS REFLECTION		
	120 lx	250 lx	500 lx
10m ²	0.8	1.8	3.5
20m ²	1.5	3.1	6.2
30m ²	2.1	4.3	8.6
50m ²	3.2	6.6	13.3
70m ²	4.3	8.9	17.8
100m ²	6.1	12.7	25.3
150m ²	8.9	18.6	37.2



216 2x36W

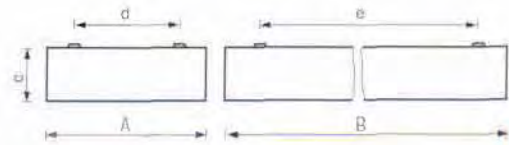

A white colour pickled steel sheet housing and frame. IP54 protection by request. Plate of polymethacrylate - OPAL. Application: laboratories, garages, dusty areas...

Ohišje in okvir iz dekapirane jeklene pločevine bele barve. Po naročilu v zaščiti IP54. Polimetakrilatna plošča - OPAL. Uporaba: laboratoriji, garaže, prašni prostori...

Корпус и рама из декапированной листової стали белого цвета. По заказу в защите ИП54. Подметакрилатная плита - ОПАЛ. Применение: лаборатории, гаражи, пыльные помещения...

Kućište i okvir iz dekapiranog čeličnog lima bijele boje. Po narudžbi u zaštiti IP54. Polimetakrilatna ploča - OPAL. Upotreba: laboratoriji, garaže, zaprašene prostori...

Code	Art.	W	Photo data	A	B	C	d	e	kg	dm ³	Price
21601181	216	1x18	27	175	640	75	100	500	3.6	10	
21601361	216	1x36	27	175	1250	75	100	930	4.6	20	
21601581	216	1x58	27	175	1550	75	100	1230	6.0	24	
21602181	216	2x18	27	285	640	75	200	500	4.1	17	
21602361	216	2x36	27	285	1250	75	200	930	6.6	32	
21602581	216	2x58	27	285	1550	75	200	1230	10.3	40	
21604181	216	4x18	28	600	640	75	510	500	6.3	34	
21604361	216	4x36	28	600	1250	75	510	930	13.0	66	

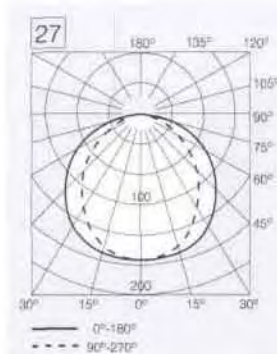

216 - 2x36		Flux CODE 44 76 97 100 59														
Index SPACE K	CIE DDR	CIE RCS	REFLECTIONS													
			873	871	773	771	753	751	731	711	551	531	511	331	000	
0.60	265	5	36	33	35	33	27	26	21	18	25	21	18	21	17	
0.80	367	5	43	39	41	38	33	31	27	23	30	26	23	26	22	
1.00	440	5	48	43	46	42	38	36	31	28	35	31	27	30	26	
1.25	513	5	52	46	49	45	43	40	36	32	39	35	32	34	30	
1.50	572	5	56	49	54	48	47	43	39	36	42	38	35	38	34	
2.00	664	5	61	53	58	52	53	48	44	42	46	44	41	43	39	
2.50	726	3	64	55	62	54	57	51	48	45	50	47	45	46	43	
3.00	771	5	66	57	64	56	59	53	50	48	52	49	48	49	45	
4.00	827	5	69	59	67	58	63	56	54	52	54	53	51	52	49	
5.00	862	5	71	60	68	59	65	57	56	54	56	55	53	53	51	
10.00	936	4	74	62	72	61	70	65	60	59	59	59	58	57	55	

531 - H(3.00-0.85)m - F1*F2=0.75			
AREA A*B	NUMBER OF LIGHTS REFLECTION		
	120lx	250lx	500lx
10m ²	0.8	1.8	3.5
20m ²	1.4	2.9	5.9
30m ²	1.9	4.0	7.9
50m ²	2.8	5.8	11.6
70m ²	3.7	7.6	15.2
100m ²	5.1	10.6	21.2
150m ²	7.3	15.3	30.5



217 2x36W

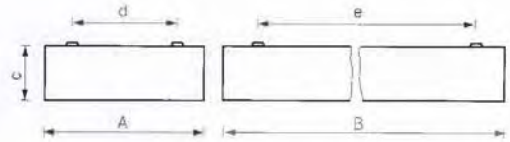

A white colour pickled steel sheet housing and frame. IP54 protection by request. Plate of polymethacrylate - DIAMOND. Application: laboratories, garages, dusty areas...

Ohišje in okvir iz dekapirane jeklene pločevine bele barve. Po naročilu v zaščiti IP54. Polimetakrilatna plošča - PRIZMATIČNA. Uporaba: laboratoriji, garaže, prašni prostori...

Корпус и рама из декапированной листовой стали белого цвета. По заказу в защите ИП54. Полиметакрилатная плита - ПРИЗМАТИЧЕСКАЯ. Применение: лаборатории, гаражи, пыльные помещения...

Kućište i okvir iz dekapiranog čeličnog lima bijele boje. Po narudžbi u zaštiti IP54. Polimetakrilatna ploča - PRIZMATIČNA. Upotreba: laboratoriji, garaže, zaprašene prostorije...

Code	Art.	W	Photo data	A	B	C	d	e	kg	dm ³	Price
21701181	217	1x18	11	175	640	75	100	500	3.6	10	
21701361	217	1x36	11	175	1250	75	100	930	4.6	20	
21701581	217	1x58	11	175	1550	75	100	1230	6.0	24	
21702181	217	2x18	11	285	640	75	200	500	4.1	17	
21702361	217	2x36	11	285	1250	75	200	930	6.6	32	
21702581	217	2x58	11	285	1550	75	200	1230	10.3	40	
21704181	217	4x18	12	600	640	75	510	500	6.3	34	
21704361	217	4x36	12	600	1250	75	510	930	13.0	66	

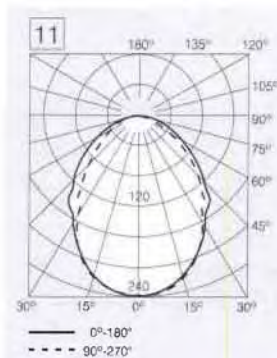

217 - 2x36		Flux CODE 51 81 98 100 58														
Index	CIE	CIE	REFLECTIONS													
SPACE K	DDR	RCS	873	871	773	771	753	751	731	711	551	531	511	331	000	
0.60	339	5	38	35	37	34	29	28	24	21	27	23	21	23	20	
0.80	422	4	44	40	43	39	35	33	29	26	32	29	26	28	24	
1.00	495	4	49	44	47	43	40	37	33	30	36	33	30	32	29	
1.25	566	4	53	47	50	46	45	41	38	35	40	37	34	36	33	
1.50	622	4	56	50	54	49	48	44	41	38	43	40	38	40	36	
2.00	708	4	61	53	59	52	54	49	46	43	48	45	43	44	41	
2.50	766	3	64	55	62	54	57	51	49	47	50	48	46	47	44	
3.00	806	4	66	57	64	56	60	53	51	49	52	50	49	49	47	
4.00	856	4	69	58	66	58	63	56	54	52	54	53	52	52	50	
5.00	886	3	70	59	68	59	65	57	56	54	56	55	54	54	51	
10.00	948	3	73	61	71	61	69	64	59	58	59	58	57	57	55	

531 - H(3.00-0.85)m - F1*F2=0.75			
AREA A*B	NUMBER OF LIGHTS REFLECTION		
	120 lx	250 lx	500 lx
10m ²	0.8	1.6	3.2
20m ²	1.3	2.7	5.4
30m ²	1.7	3.6	7.3
50m ²	2.6	5.4	10.8
70m ²	3.4	7.2	14.3
100m ²	4.8	10.0	20.0
150m ²	7.0	14.5	29.0



246 2x36W

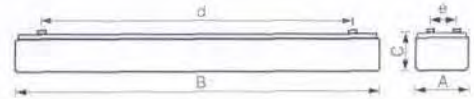

The base is of white pickled steel sheet, the cap of polymethacrylate - OPAL - lower lighting and engineering requirements. Application: dry areas, offices, storage facilities, garages...

Podnožje iz dekapirane jeklene pločevine bele barve. Kapa iz polimetakrilata - OPAL - niže svetlobnotehnične zahteve. Uporaba: suhi prostori, pisarne, skladišča, garaže...

Подножие из декапированной листовой стали белого цвета. Кривка из полиметакрилата - ОПАЛ - низкие световые технические требования. Применение: сухие помещения, офисы, склады, гаражи...

Podnožje iz dekapiranog čeličnog lima bijele boje. Kapa iz polimetakrilata - OPAL - niži svjetlosnotehnički zahtjev. Upotreba: suhe prostorije, kancelarije, skladišta, garaže...

Code	Art.	W	Photo data	A	B	C	d	e	kg	dm ³	Price
24601181	246	1x18	21	110	670	65	40	500	1.30	4.8	
24601361	246	1x36	21	110	1270	65	40	920	1.75	9.1	
24602181	246	2x18	22	200	670	60	110	380	1.80	6.1	
24602361	246	2x36	22	200	1270	60	110	920	3.90	15.3	
24602581	246	2x58	22	200	1572	60	110	1220	4.60	19.0	
24603361	246	3x36	23	297	1270	60	170	920	4.90	22.7	
24604181	246	4x18	23	664	664	60	380	400	6.20	26.5	

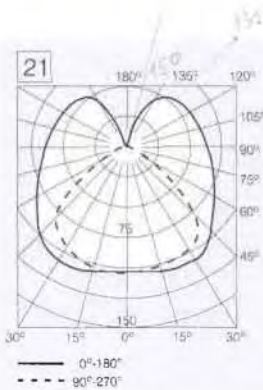

246 - 2x36		Flux CODE 37 66 87 73 72													
Index SPACE K	CIE DDR	CIE RCS	REFLECTIONS												
			873	871	773	771	753	751	731	711	551	531	511	331	000
0.60	244	7	40	37	37	35	28	27	22	18	24	20	17	18	13
0.80	316	7	47	43	44	40	34	33	27	23	30	25	21	23	17
1.00	381	7	53	47	49	45	40	37	32	28	34	29	26	27	20
1.25	449	7	58	51	53	49	45	42	37	32	38	34	30	31	24
1.50	503	7	62	54	58	52	49	45	40	36	41	37	34	34	27
2.00	588	7	67	59	63	56	56	50	46	42	46	42	39	39	31
2.50	644	7	71	61	66	58	60	54	50	46	49	46	43	42	34
3.00	684	7	73	63	69	60	63	56	52	49	51	48	45	44	36
4.00	730	7	77	65	71	62	66	58	55	53	53	51	49	47	38
5.00	756	7	78	66	73	63	69	60	57	55	55	53	50	48	40
10.00	795	9	82	68	76	65	73	67	61	58	57	55	54	51	42

531 - H(3.00-0.85)m - F1*F2 - 0.75			
AREA A*B	NUMBER OF LIGHTS REFLECTION		
	120 lx	250 lx	500 lx
10m ²	0.9	1.8	3.6
20m ²	1.4	2.9	5.9
30m ²	1.9	3.9	7.9
50m ²	2.8	5.8	11.5
70m ²	3.6	7.5	15.1
100m ²	5.0	10.5	21.0
150m ²	7.3	15.1	30.3



247 2x36W



The base is of white pickled steel sheet, the cap of polymethacrylate - DIAMOND - medium lighting and engineering requirements. Application: dry areas, offices, storage facilities, garages...

Podnožje iz dekapirane jeklene pločevine bele barve. Kapa iz polimetakrilata - PRIZMATIČNA - srednje svetlobnotehnične zahteve. Uporaba: suhi prostori, pisarne, skladišča, garaže...

Подножје из декапированной листовой стали белого цвета. Крышка из полиметакрилата - ПРИЗМАТИЧЕСКАЯ - средние световые технические требования. Применение: сухие помещения, офисы, склады, гаражи...

Podnožje iz dekapiranog čeličnog lima bijele boje. Kapa iz polimetakrilata - PRIZMATIČNA - srednji svjetlosnotehnički zahtjev. Upotreba: suhe prostorije, kancelarije, skladišta, garaže...

Code	Art	W	Photo data	A	B	C	d	e	kg	dm ³	Price
24701181	247	1x18	24	110	670	65	40	500	1.30	4.8	
24701361	247	1x36	24	110	1270	65	40	920	1.75	9.1	
24702181	247	2x18	25	200	670	60	110	380	1.80	8.1	
24702361	247	2x36	25	200	1270	60	110	920	3.90	15.3	
24702581	247	2x58	25	200	1572	60	110	1220	4.60	19.0	
24703361	247	3x36	26	297	1270	60	170	920	4.90	22.7	
24704181	247	4x18	26	664	664	60	380	400	6.29	26.5	

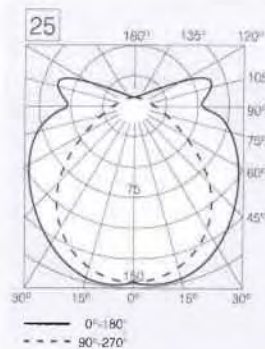

247 - 2x36		Flux CODE 44 71 88 75 69														
Index SPACE K	CIE DDR	CIE RCS	REFLECTIONS													
			873	871	773	771	753	751	731	711	551	531	511	331	000	
0.60	354	4	37	34	36	33	28	27	23	20	25	22	19	21	17	
0.80	426	4	43	39	41	37	33	32	28	25	30	26	24	25	20	
1.00	490	4	47	43	45	41	38	35	31	28	33	30	27	28	23	
1.25	553	5	51	46	48	44	42	39	35	32	36	33	31	31	26	
1.50	601	5	54	48	52	46	45	42	38	35	39	36	33	34	29	
2.00	676	5	59	51	56	49	50	45	42	40	42	40	38	38	32	
2.50	724	3	62	53	58	51	53	48	45	43	45	42	40	40	35	
3.00	758	5	63	54	60	52	56	50	47	45	46	44	42	42	36	
4.00	795	6	66	56	62	54	58	51	49	47	48	46	45	43	38	
5.00	815	6	67	57	63	55	60	53	51	49	49	47	46	44	39	
10.00	845	8	70	58	65	56	63	58	53	51	51	49	48	46	40	

531 - H(3.00-0.85)m - F1*F2=0.75			
AREA A*B	NUMBER OF LIGHTS REFLECTION		
	120 lx	250 lx	500 lx
10m ²	0.8	1.7	3.5
20m ²	1.4	3.0	6.0
30m ²	2.0	4.1	8.2
50m ²	2.9	6.1	12.2
70m ²	3.9	8.1	16.2
100m ²	5.5	11.4	22.7
150m ²	7.9	16.5	33.0



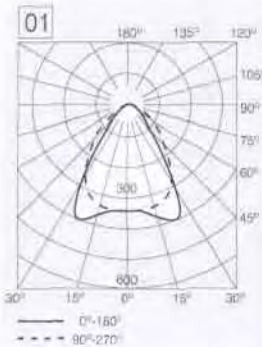

Photo Data 01				Flux CODE 83 100 100 100 61															
Index SPACE K	CIE DDR	CIE RCS	REFLECTIONS																
				873	871	773	771	753	751	731	711	551	531	511	331	000			
0.60	580	-	51 47 50 46 43 42 39 36 41 38 36 38 36																
0.80	655	-	56 51 55 50 49 46 43 41 46 43 41 43 40																
1.00	720	-	61 54 59 54 54 50 47 46 49 47 45 47 44																
1.25	775	-	64 57 61 56 58 53 51 49 52 50 49 50 47																
1.50	813	-	67 59 65 58 60 55 53 52 55 53 51 52 50																
2.00	871	-	70 61 68 61 65 59 57 56 58 56 55 56 53																
2.50	906	-	73 63 71 62 67 60 59 58 59 58 57 58 55																
3.00	929	-	74 64 72 63 69 62 61 60 61 60 59 59 57																
4.00	950	-	76 64 73 64 71 63 62 61 62 61 60 60 58																
5.00	961	-	77 65 74 64 72 63 63 62 62 62 61 61 59																
10.00	982	-	79 66 76 65 75 69 64 64 63 63 63 62 60																

Reflection control L 36/21 2*3.35 km					
gamma angle	90°-270°		0°-180°		
	range 1 lx	range 2 lx	lumini- nity cd/m ²	range 1 lx	range 2 lx
85°			0	<=2000	<=2000
75°	<=500	<=2000	0	<=2000	<=2000
65°	<=1000	<=2000	0	<=2000	<=2000
55°	<=2000	<=2000	0	<=2000	<=2000
45°	<=1000	<=2000	5398	<=2000	<=2000

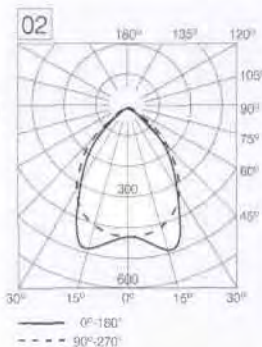

Photo Data 02				Flux CODE 81 100 100 100 67															
Index SPACE K	CIE DDR	CIE RCS	REFLECTIONS																
				873	871	773	771	753	751	731	711	551	531	511	331	000			
0.60	562	1	55 51 54 50 47 45 41 39 44 41 39 41 38																
0.80	641	-	61 56 60 55 53 50 47 45 50 47 44 46 43																
1.00	708	-	66 59 65 59 58 55 52 49 54 51 49 51 48																
1.25	765	-	70 62 67 62 63 58 56 53 57 55 53 54 52																
1.50	805	-	73 64 71 64 66 61 58 56 60 58 56 57 54																
2.00	865	-	77 67 75 66 71 64 62 61 63 62 60 61 58																
2.50	900	-	80 69 77 68 74 66 65 63 65 64 63 63 61																
3.00	924	-	81 70 79 69 76 68 66 65 66 65 64 64 62																
4.00	945	-	83 71 81 70 78 69 68 67 68 67 66 66 64																
5.00	956	-	84 71 82 71 79 70 69 68 68 68 67 67 64																
10.00	977	-	86 72 83 72 82 76 71 70 70 69 69 68 66																

Reflection control L 18/21 4*1.35 km					
gamma angle	90°-270°		0°-180°		
	range 1 lx	range 2 lx	lumini- nity cd/m ²	range 1 lx	range 2 lx
85°		<=250	0	<=2000	<=2000
75°	<=500	<=2000	0	<=2000	<=2000
65°	<=2000	<=2000	0	<=2000	<=2000
55°	<=2000	<=2000	0	<=2000	<=2000
45°	<=2000	<=2000	3236	<=2000	<=2000

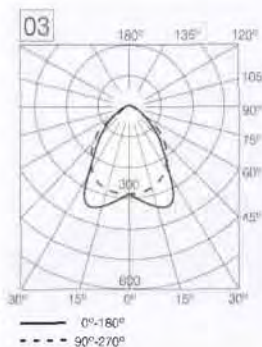

Photo Data 03				Flux CODE 90 100 100 100 57															
Index SPACE K	CIE DDR	CIE RCS	REFLECTIONS																
				873	871	773	771	753	751	731	711	551	531	511	331	000			
0.60	648	-	37 34 36 34 32 31 29 28 31 29 28 29 27																
0.80	710	-	40 37 40 36 36 34 32 31 33 32 31 32 32																
1.00	766	-	43 39 42 38 39 36 35 33 36 34 33 34 32																
1.25	812	-	45 40 43 40 41 38 37 35 37 36 35 36 34																
1.50	844	-	47 41 46 41 43 39 38 37 39 38 37 37 36																
2.00	896	-	49 43 48 42 45 41 40 39 41 40 39 39 38																
2.50	928	-	51 44 49 43 47 42 42 41 42 41 40 41 39																
3.00	950	-	52 44 50 44 48 43 43 42 42 42 41 41 40																
4.00	968	-	53 45 51 44 50 44 43 43 43 43 42 42 41																
5.00	978	-	53 45 52 45 51 44 44 44 44 43 43 43 41																
10.00	998	-	55 46 53 45 52 48 45 45 44 44 44 43 42																

Reflection control L 36/21 2*3.35 km					
gamma angle	90°-270°		0°-180°		
	range 1 lx	range 2 lx	lumini- nity cd/m ²	range 1 lx	range 2 lx
85°	<=2000	<=2000	0	<=2000	<=2000
75°	<=2000	<=2000	0	<=2000	<=2000
65°	<=2000	<=2000	0	<=2000	<=2000
55°	<=2000	<=2000	0	<=2000	<=2000
45°	<=2000	<=2000	467	<=2000	<=2000

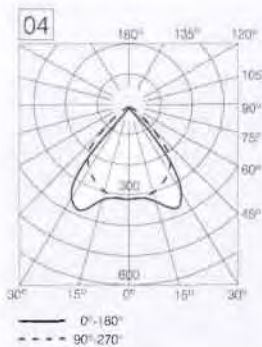

Photo Data 04				Flux CODE 78 100 100 100 59															
Index SPACE K	CIE DDR	CIE RCS	REFLECTIONS																
				873	871	773	771	753	751	731	711	551	531	511	331	000			
0.60	538	1	47 43 46 43 40 38 35 33 37 35 33 34 32																
0.80	621	1	53 48 51 47 45 43 40 38 42 40 38 39 37																
1.00	692	1	57 51 56 51 50 47 44 42 46 44 42 43 41																
1.25	752	1	61 54 58 53 54 50 48 46 49 47 46 47 44																
1.50	794	-	63 56 62 55 57 52 50 48 52 50 48 49 47																
2.00	856	-	67 58 65 58 61 56 54 52 55 53 52 53 50																
2.50	892	-	69 60 67 59 64 57 56 55 56 55 54 55 52																
3.00	917	-	71 61 69 60 66 59 58 56 58 57 56 56 54																
4.00	938	-	72 62 70 61 68 60 59 58 59 58 57 57 55																
5.00	950	-	73 62 71 61 69 61 60 59 59 59 58 58 56																
10.00	972	1	75 63 73 62 71 66 61 61 61 60 60 59 57																

Reflection control L 18/21 4*1.35 km					
gamma angle	90°-270°		0°-180°		
	range 1 lx	range 2 lx	lumini- nity cd/m ²	range 1 lx	range 2 lx
85°		<=250	0	<=2000	<=2000
75°	<=250	<=1000	0	<=2000	<=2000
65°	<=2000	<=2000	0	<=2000	<=2000
55°	<=2000	<=2000	0	<=2000	<=2000
45°	<=2000	<=2000	2580	<=2000	<=2000

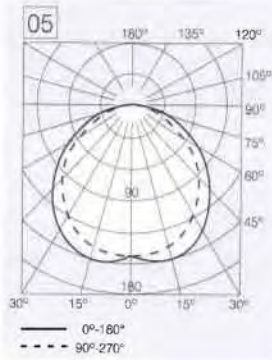

Photo Data 05			Flux CODE 49 83 98 100 42															
Index SPACE K	CIE DDR	CIE RCS	REFLECTIONS															
			873	871	773	771	753	751	731	711	551	531	511	331	000			
0.60	317	5	27	25	26	24	20	19	16	14	19	16	14	16	13			
0.80	408	5	31	28	30	28	25	23	20	18	23	20	18	20	17			
1.00	485	5	35	31	34	31	29	27	24	21	26	23	21	23	20			
1.25	560	4	38	34	36	33	32	30	27	25	29	26	25	26	23			
1.50	617	4	41	36	39	35	35	32	29	27	31	29	27	28	26			
2.00	705	4	44	38	42	38	39	35	33	31	34	32	31	32	29			
2.50	762	3	46	40	45	39	41	37	35	34	36	35	33	34	32			
3.00	802	4	48	41	46	40	43	38	37	35	38	36	35	36	34			
4.00	850	4	49	42	48	41	45	40	39	38	39	38	37	37	36			
5.00	879	4	51	43	49	42	47	41	40	39	40	39	38	38	37			
10.00	939	4	53	44	51	44	50	46	42	42	42	42	41	41	39			

Reflection control 36/21 PL 2*2.9 klm					
gamma angle	90°-270°		0°-180°		
	range 1 lx	range 2 lx	luminosity cd/m ²	range 1 lx	range 2 lx
85°	<=2000	<=2000	378	<=2000	<=2000
75°	<=2000	<=2000	1272	<=2000	<=2000
65°	<=2000	<=2000	1948	<=2000	<=2000
55°	<=2000	<=2000	2297	<=2000	<=2000
45°	<=2000	<=2000	2515	<=2000	<=2000

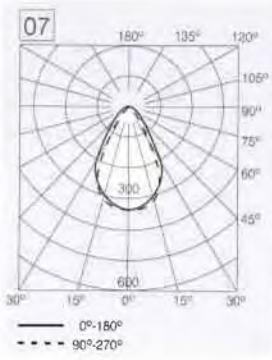

Photo Data 07			Flux CODE 65 95 100 100 57															
Index SPACE K	CIE DDR	CIE RCS	REFLECTIONS															
			873	871	773	771	753	751	731	711	551	531	511	331	000			
0.60	429	3	41	38	40	37	33	32	28	26	31	28	26	28	25			
0.80	524	3	47	43	46	42	40	37	34	31	37	33	31	33	30			
1.00	602	2	52	47	51	46	45	42	38	36	41	38	36	38	34			
1.25	673	2	56	50	54	49	49	45	42	40	45	42	40	41	38			
1.50	723	2	59	52	57	51	52	48	45	43	47	45	43	44	41			
2.00	799	2	63	55	61	54	57	52	50	48	51	49	47	48	46			
2.50	843	2	66	57	64	56	60	54	52	51	53	51	50	51	48			
3.00	874	2	67	58	65	57	62	55	54	53	54	53	52	52	50			
4.00	905	2	69	59	67	58	65	57	56	55	56	55	54	54	52			
5.00	922	2	70	60	68	59	66	58	57	56	57	56	55	55	53			
10.00	956	2	73	61	70	60	69	64	59	58	58	58	57	57	55			

Reflection control L 36/21 2*3.35 klm					
gamma angle	90°-270°		0°-180°		
	range 1 lx	range 2 lx	luminosity cd/m ²	range 1 lx	range 2 lx
85°	<=2000	<=2000	17181	<=250	<=250
75°	<=2000	<=2000	5105	<=250	<=1000
65°	<=2000	<=2000	2710	<=1000	<=2000
55°	<=2000	<=2000	4326	<=1000	<=2000
45°	<=2000	<=2000	4588	<=2000	<=2000

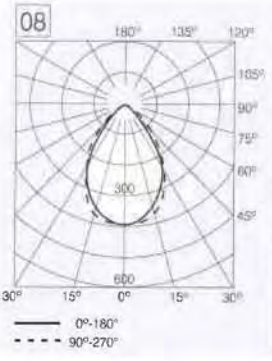

Photo Data 08			Flux CODE 70 100 100 100 64															
Index SPACE K	CIE DDR	CIE RCS	REFLECTIONS															
			873	871	773	771	753	751	731	711	551	531	511	331	000			
0.60	458	2	47	43	46	43	39	37	33	30	36	33	30	33	29			
0.80	558	2	54	49	53	49	46	43	40	37	43	39	37	39	36			
1.00	638	2	60	54	58	53	52	48	45	42	47	44	42	44	41			
1.25	709	1	64	57	61	56	57	52	49	47	51	49	47	48	45			
1.50	757	1	67	59	66	59	60	55	52	50	54	52	50	51	48			
2.00	828	1	72	62	70	62	65	59	57	55	58	56	55	55	53			
2.50	867	1	74	64	72	63	68	61	59	58	60	59	57	58	55			
3.00	893	1	76	65	74	64	70	63	61	60	61	60	59	59	57			
4.00	917	1	78	66	75	65	73	64	63	62	63	62	61	61	59			
5.00	929	1	79	67	76	66	74	65	64	63	64	63	62	62	59			
10.00	953	2	81	68	78	67	77	71	66	65	65	64	64	63	61			

Reflection control L 18/21 4*1.35 klm					
gamma angle	90°-270°		0°-180°		
	range 1 lx	range 2 lx	luminosity cd/m ²	range 1 lx	range 2 lx
85°	<=2000	<=2000	0	<=2000	<=2000
75°	<=2000	<=2000	0	<=2000	<=2000
65°	<=2000	<=2000	0	<=2000	<=2000
55°	<=2000	<=2000	1330	<=2000	<=2000
45°	<=2000	<=2000	3667	<=2000	<=2000

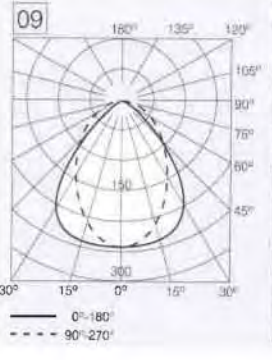

Photo Data 09			Flux CODE 70 100 100 100 42															
Index SPACE K	CIE DDR	CIE RCS	REFLECTIONS															
			873	871	773	771	753	751	731	711	551	531	511	331	000			
0.60	462	2	31	29	30	28	25	24	22	20	24	22	20	22	19			
0.80	561	2	36	32	35	32	30	29	26	24	28	26	24	26	23			
1.00	640	2	39	35	38	35	34	32	30	28	31	29	28	29	27			
1.25	711	1	42	37	40	37	37	34	32	31	34	32	31	32	30			
1.50	759	1	44	39	43	38	39	36	34	33	36	34	33	34	32			
2.00	829	1	47	41	46	40	43	39	37	36	38	37	36	36	35			
2.50	868	1	49	42	47	42	45	40	39	38	39	38	38	38	36			
3.00	894	1	50	43	48	42	46	41	40	39	40	40	39	39	37			
4.00	918	1	51	43	49	43	48	42	41	41	41	41	40	40	38			
5.00	930	1	52	44	50	43	48	43	42	41	42	41	41	40	39			
10.00	954	2	53	44	51	44	50	46	43	43	43	42	42	41	40			

Reflection control L 36/21 2*3.35 klm					
gamma angle	90°-270°		0°-180°		
	range 1 lx	range 2 lx	luminosity cd/m ²	range 1 lx	range 2 lx
85°	<=2000	<=2000	0	<=2000	<=2000
75°	<=2000	<=2000	0	<=2000	<=2000
65°	<=2000	<=2000	0	<=2000	<=2000
55°	<=2000	<=2000	1325	<=2000	<=2000
45°	<=2000	<=2000	2957	<=2000	<=2000

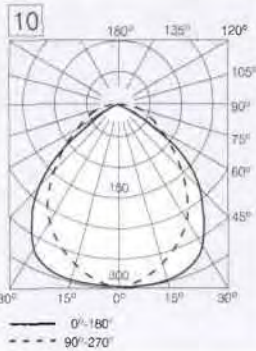

Photo Data 10				Flux CODE 62 94 100 100 64															
Index SPACE K	CIE DDR	CIE RCS	REFLECTIONS																
			873	871	773	771	753	751	731	711	551	531	511	331	000				
0.60	402	3	45	41	44	41	36	34	30	27	34	30	27	30	26				
0.80	500	3	52	47	51	47	43	41	37	34	40	36	34	36	32				
1.00	580	3	58	52	56	51	49	46	42	39	45	41	39	41	37				
1.25	654	3	63	56	60	55	54	50	47	44	49	46	44	46	42				
1.50	707	2	66	58	64	57	58	53	50	48	52	49	47	49	45				
2.00	785	2	71	62	69	61	64	58	55	53	56	54	52	53	51				
2.50	832	2	74	64	71	63	67	60	58	56	59	57	56	56	54				
3.00	863	2	75	65	71	63	67	60	58	56	59	57	56	56	54				
4.00	897	2	78	66	75	65	72	64	62	61	62	61	60	60	58				
5.00	915	2	79	67	76	66	74	65	63	62	63	62	61	61	59				
10.00	952	2	82	68	79	68	77	71	66	65	65	65	64	64	61				

Reflection control L 18/21 4*1.35 klm					
gamma angle	90°-270°		0°-180°		
	range 1 lx	range 2 lx	lumi-nosity cd/m ²	range 1 lx	range 2 lx
85°		<=250	5869		<=500
75°	<=250	<=1000	1744	<=1000	<=2000
65°	<=1000	<=2000	926	<=2000	<=2000
55°	<=2000	<=2000	3001	<=2000	<=2000
45°	<=2000	<=2000	3762	<=2000	<=2000

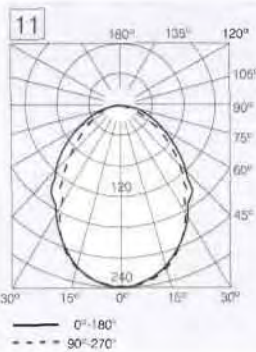

Photo Data 11				Flux CODE 51 81 98 100 58															
Index SPACE K	CIE DDR	CIE RCS	REFLECTIONS																
			873	871	773	771	753	751	731	711	551	531	511	331	000				
0.60	339	5	38	35	37	34	29	28	24	21	27	23	21	23	20				
0.80	422	4	44	40	43	39	35	33	29	26	32	29	26	28	24				
1.00	495	4	49	44	47	43	40	37	33	30	36	33	30	32	29				
1.25	566	4	53	47	50	46	45	41	38	35	40	37	34	36	33				
1.50	622	4	56	50	54	49	48	44	41	38	43	40	38	40	36				
2.00	708	4	61	53	59	52	54	49	46	43	48	45	43	44	41				
2.50	766	3	64	55	62	54	57	51	49	47	50	48	46	47	44				
3.00	806	4	66	57	64	56	60	53	51	49	52	50	49	49	47				
4.00	856	4	69	58	66	58	63	56	54	52	54	53	52	52	50				
5.00	886	3	70	59	68	59	65	57	56	54	56	55	54	54	51				
10.00	948	3	73	61	71	61	69	64	59	58	59	58	57	57	55				

Reflection control L 36/21 2*3.35 klm					
gamma angle	90°-270°		0°-180°		
	range 1 lx	range 2 lx	lumi-nosity cd/m ²	range 1 lx	range 2 lx
85°		<=500	8650		<=500
75°	<=500	<=2000	2570	<=500	<=2000
65°	<=1000	<=2000	3238	<=2000	<=2000
55°	<=2000	<=2000	3314	<=2000	<=2000
45°	<=2000	<=2000	3763	<=2000	<=2000

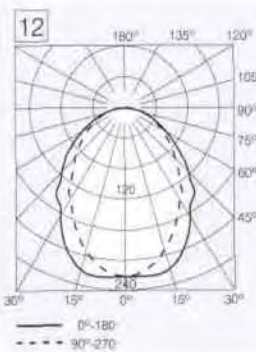

Photo Data 12				Flux CODE 52 82 98 100 66															
Index SPACE K	CIE DDR	CIE RCS	REFLECTIONS																
			873	871	773	771	753	751	731	711	551	531	511	331	000				
0.60	345	4	43	40	42	39	33	32	27	24	31	27	24	27	23				
0.80	429	4	50	46	49	45	40	38	33	30	37	33	30	32	28				
1.00	502	4	56	50	54	49	46	43	38	35	42	38	35	37	33				
1.25	573	4	61	54	57	53	51	47	43	40	46	42	39	42	38				
1.50	628	4	64	57	62	56	55	51	47	44	49	46	43	45	41				
2.00	714	4	70	61	67	60	61	56	52	50	54	51	49	51	47				
2.50	770	3	73	63	71	62	65	59	56	53	57	55	53	54	51				
3.00	810	4	75	65	73	64	68	61	58	56	59	57	56	56	53				
4.00	858	4	78	66	75	66	72	63	62	60	62	60	59	59	56				
5.00	887	3	80	67	77	67	74	65	63	62	64	62	61	61	58				
10.00	947	3	83	70	80	69	79	73	67	66	67	66	65	65	62				

Reflection control L 18/21 4*1.35 klm					
gamma angle	90°-270°		0°-180°		
	range 1 lx	range 2 lx	lumi-nosity cd/m ²	range 1 lx	range 2 lx
85°		<=500	9917		<=250
75°	<=1000	<=2000	2947	<=500	<=2000
65°	<=1000	<=2000	2887	<=1000	<=2000
55°	<=2000	<=2000	3191	<=2000	<=2000
45°	<=2000	<=2000	3236	<=2000	<=2000

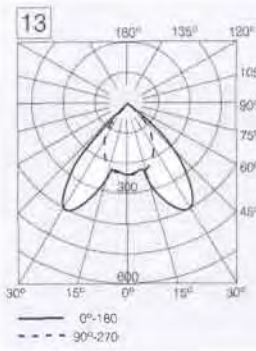

Photo Data 13				Flux CODE 83 100 100 100 61															
Index SPACE K	CIE DDR	CIE RCS	REFLECTIONS																
			873	871	773	771	753	751	731	711	551	531	511	331	000				
0.60	580	-	51	47	50	46	43	42	39	36	41	38	36	38	36				
0.80	655	-	56	51	55	50	49	46	43	41	46	43	41	43	40				
1.00	720	-	61	54	59	54	54	50	47	46	49	47	45	47	44				
1.25	775	-	64	57	61	56	58	53	51	49	52	50	49	50	47				
1.50	813	-	67	59	65	58	60	55	53	52	55	53	51	52	50				
2.00	871	-	70	61	68	61	65	59	57	56	58	56	55	56	53				
2.50	906	-	73	63	71	62	67	60	59	58	59	58	57	58	55				
3.00	929	-	74	64	72	63	69	62	61	60	61	60	59	59	57				
4.00	950	-	76	64	73	64	71	63	62	61	62	61	60	60	58				
5.00	961	-	77	65	74	64	72	63	63	62	62	62	61	61	59				
10.00	982	-	79	66	76	65	75	69	64	64	63	63	63	62	60				

Reflection control L 36/21 1*3.35 klm					
gamma angle	90°-270°		0°-180°		
	range 1 lx	range 2 lx	lumi-nosity cd/m ²	range 1 lx	range 2 lx
85°			0	<=2000	<=2000
75°		<=500	0	<=2000	<=2000
65°	<=250	<=1000	0	<=2000	<=2000
55°	<=2000	<=2000	0	<=2000	<=2000
45°	<=2000	<=2000	1910	<=2000	<=2000

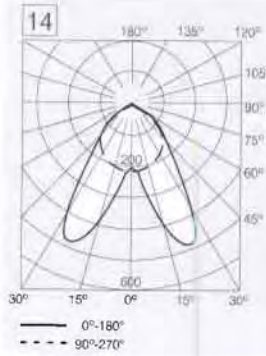

Photo Data 14			Flux CODE 88 100 100 100 57												
Index SPACE K	CIE DDR	CIE RCS	REFLECTIONS												
			873	871	773	771	753	751	731	711	551	531	511	331	000
0.60	628	-	49	45	48	44	42	41	38	36	40	38	36	38	36
0.80	694	-	53	48	52	48	47	44	42	40	44	42	40	41	39
1.00	753	-	57	51	56	51	51	48	45	44	47	45	44	45	43
1.25	801	-	60	53	58	53	54	50	48	47	50	48	46	47	45
1.50	835	-	62	55	61	54	57	52	50	49	51	50	48	49	47
2.00	889	-	66	57	64	56	60	55	53	52	54	53	52	52	50
2.50	921	-	67	58	66	58	63	56	55	54	55	54	54	54	52
3.00	944	-	69	59	67	58	64	57	57	56	56	56	55	55	53
4.00	963	-	70	60	68	59	66	58	58	57	57	57	56	56	54
5.00	973	-	71	60	69	60	67	59	58	58	58	57	57	57	55
10.00	993	-	73	61	70	60	70	64	60	60	59	59	59	58	56

Reflection control L 36/21 1*3.35 klm					
gamma angle	90°-270°		0°-180°		
	range 1 lx	range 2 lx	lumi-nosity cd/m ²	range 1 lx	range 2 lx
85°			0	<=2000	<=2000
75°		<=500	0	<=2000	<=2000
65°	<=250	<=1000	0	<=2000	<=2000
55°	<=2000	<=2000	0	<=2000	<=2000
45°	<=2000	<=2000	382	<=2000	<=2000

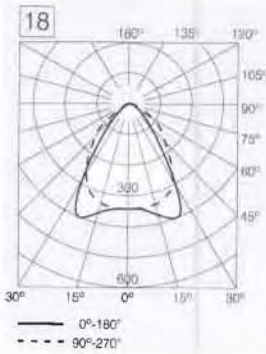

Photo Data 18			Flux CODE 83 100 100 100 61												
Index SPACE K	CIE DDR	CIE RCS	REFLECTIONS												
			873	871	773	771	753	751	731	711	551	531	511	331	000
0.60	580	-	51	47	50	46	43	42	39	36	41	38	36	38	36
0.80	655	-	56	51	55	50	49	46	43	41	46	43	41	43	40
1.00	720	-	61	54	59	54	54	50	47	46	49	47	45	47	44
1.25	775	-	64	57	61	56	58	53	51	49	52	50	49	50	47
1.50	813	-	67	59	65	58	60	55	53	52	55	53	51	52	50
2.00	871	-	70	61	68	61	65	59	57	56	58	56	55	56	53
2.50	906	-	73	63	71	62	67	60	59	58	59	58	57	58	55
3.00	929	-	74	64	72	63	69	62	61	60	61	60	59	59	57
4.00	950	-	76	64	73	64	71	63	62	61	62	61	60	60	58
5.00	961	-	77	65	74	64	72	63	63	62	62	62	61	61	59
10.00	982	-	79	66	76	65	75	69	64	64	63	63	63	62	60

Reflection control L 36/21 2*3.35 klm					
gamma angle	90°-270°		0°-180°		
	range 1 lx	range 2 lx	lumi-nosity cd/m ²	range 1 lx	range 2 lx
85°		<=250	0	<=2000	<=2000
75°	<=500	<=2000	0	<=2000	<=2000
65°	<=1000	<=2000	0	<=2000	<=2000
55°	<=2000	<=2000	0	<=2000	<=2000
45°	<=2000	<=2000	2669	<=2000	<=2000

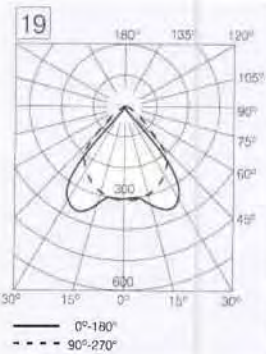

Photo Data 19			Flux CODE 88 100 100 100 57												
Index SPACE K	CIE DDR	CIE RCS	REFLECTIONS												
			873	871	773	771	753	751	731	711	551	531	511	331	000
0.60	628	-	49	45	48	44	42	41	38	36	40	38	36	38	36
0.80	694	-	53	48	52	48	47	44	42	40	44	42	40	41	39
1.00	753	-	57	51	56	51	51	48	45	44	47	45	44	45	43
1.25	801	-	60	53	58	53	54	50	48	47	50	48	46	47	45
1.50	835	-	62	55	61	54	57	52	50	49	51	50	48	49	47
2.00	889	-	66	57	64	56	60	55	53	52	54	53	52	52	50
2.50	921	-	67	58	66	58	63	56	55	54	55	54	54	54	52
3.00	944	-	69	59	67	58	64	57	57	56	56	56	55	55	53
4.00	963	-	70	60	68	59	66	58	58	57	57	57	56	56	54
5.00	973	-	71	60	69	60	67	59	58	58	58	57	57	57	55
10.00	993	-	73	61	70	60	70	64	60	60	59	59	59	58	56

Reflection control L 36/21 2*3.35 klm					
gamma angle	90°-270°		0°-180°		
	range 1 lx	range 2 lx	lumi-nosity cd/m ²	range 1 lx	range 2 lx
85°		<=250	0	<=2000	<=2000
75°	<=250	<=1000	0	<=2000	<=2000
65°	<=2000	<=2000	0	<=2000	<=2000
55°	<=2000	<=2000	0	<=2000	<=2000
45°	<=2000	<=2000	1534	<=2000	<=2000

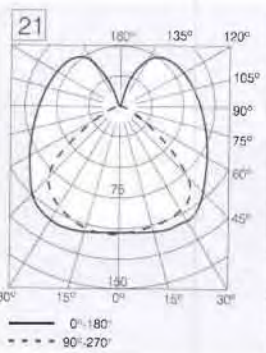

Photo Data 21			Flux CODE 32 60 83 67 68												
Index SPACE K	CIE DDR	CIE RCS	REFLECTIONS												
			873	871	773	771	753	751	731	711	551	531	511	331	000
0.60	210	7	36	33	34	31	24	23	18	15	21	17	14	15	10
0.80	276	7	43	39	40	36	30	29	23	20	26	21	18	19	13
1.00	338	7	48	43	44	40	35	33	28	24	29	25	22	22	15
1.25	403	7	53	47	48	44	40	37	32	28	33	29	25	26	18
1.50	456	7	56	50	52	47	44	40	35	32	36	32	29	28	21
2.00	540	7	61	53	57	50	50	45	41	37	40	37	34	33	25
2.50	597	7	65	56	60	53	54	48	44	41	43	40	37	36	27
3.00	637	7	67	58	62	54	56	50	47	43	45	42	39	37	29
4.00	685	7	70	60	65	56	60	53	50	47	47	45	42	40	31
5.00	711	7	72	61	66	58	62	54	51	49	49	46	44	41	32
10.00	749	9	75	63	69	59	66	60	54	52	51	49	47	43	34

Reflection control L 36/21 1*3.35 klm					
gamma angle	90°-270°		0°-180°		
	range 1 lx	range 2 lx	lumi-nosity cd/m ²	range 1 lx	range 2 lx
85°	<=2000	<=2000	12025		
75°	<=500	<=2000	6118		
65°	<=1000	<=2000	4446		<=500
55°	<=2000	<=2000	3603	<=500	<=2000
45°	<=2000	<=2000	3103	<=1000	<=2000

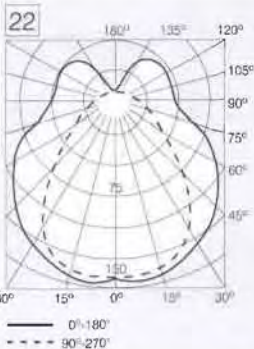

Photo Data 22			Flux CODE 37 66 87 73 72												
Index SPACE K	CIE DDR	CIE RCS	REFLECTIONS												
			873	871	773	771	753	751	731	711	551	531	511	331	000
0.60	244	7	40	37	37	35	28	27	22	18	24	20	17	18	13
0.80	316	7	47	43	44	40	34	33	27	23	30	25	21	23	17
1.00	381	7	53	47	49	45	40	37	32	28	34	29	26	27	20
1.25	449	7	58	51	53	49	45	42	37	32	38	34	30	31	24
1.50	503	7	62	54	58	52	49	45	40	36	41	37	34	34	27
2.00	588	7	67	59	63	56	56	50	46	42	46	42	39	39	31
2.50	644	7	71	61	66	58	60	54	50	46	49	46	43	42	34
3.00	684	7	73	63	69	60	63	56	52	49	51	48	45	44	36
4.00	730	7	77	65	71	62	66	58	55	53	53	51	49	47	38
5.00	756	7	78	66	73	63	69	60	57	55	55	53	50	48	40
10.00	795	9	82	68	76	65	73	67	61	58	57	55	54	51	42

Reflection control L 36/21					
2*3.35 klm					
gamma angle	90°-270°		0°-180°		
	range 1 lx	range 2 lx	luminosity cd/m ²	range 1 lx	range 2 lx
85°	<=250	<=1000	12152		
75°		<=500	6743		
65°	<=500	<=2000	5391		<=500
55°	<=2000	<=2000	4705	<=500	<=2000
45°	<=1000	<=2000	4255	<=1000	<=2000

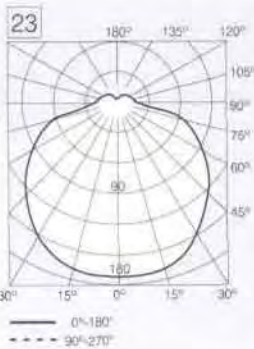

Photo Data 23			Flux CODE 43 74 92 86 66												
Index SPACE K	CIE DDR	CIE RCS	REFLECTIONS												
			873	871	773	771	753	751	731	711	551	531	511	331	000
0.60	279	6	39	36	37	35	29	27	22	19	26	21	18	21	16
0.80	358	6	46	42	44	40	35	33	28	24	31	27	23	26	20
1.00	429	6	51	46	49	44	40	38	33	29	36	31	28	30	24
1.25	500	6	56	50	53	48	46	42	37	34	40	36	32	34	28
1.50	555	6	60	53	57	51	50	45	41	37	43	39	36	37	32
2.00	642	6	65	57	62	55	56	50	47	43	48	44	42	42	37
2.50	699	6	69	59	65	57	60	53	50	47	51	48	45	45	40
3.00	739	6	71	61	68	59	62	56	53	50	53	50	48	48	42
4.00	787	6	74	63	70	61	66	58	56	53	55	53	51	50	45
5.00	815	6	76	64	72	62	68	60	57	55	56	55	53	52	46
10.00	864	7	79	66	75	64	72	67	61	59	59	58	56	55	49

Reflection control L 18/21					
4*1.35 klm					
gamma angle	90°-270°		0°-180°		
	range 1 lx	range 2 lx	luminosity cd/m ²	range 1 lx	range 2 lx
85°	<=2000	<=2000	1635	<=250	<=1000
75°	<=900	<=2000	1752	<=250	<=1000
65°	<=1000	<=2000	1856	<=1000	<=2000
55°	<=2000	<=2000	1956	<=2000	<=2000
45°	<=2000	<=2000	2010	<=2000	<=2000

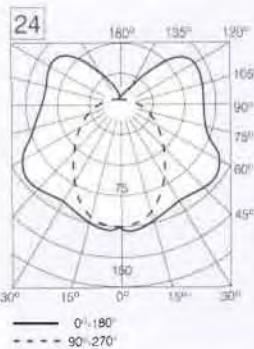

Photo Data 24			Flux CODE 44 71 88 75 69												
Index SPACE K	CIE DDR	CIE RCS	REFLECTIONS												
			873	871	773	771	753	751	731	711	551	531	511	331	000
0.60	294	5	40	37	38	35	29	28	23	20	26	22	19	20	15
0.80	365	5	47	43	44	41	35	33	28	25	31	26	23	25	19
1.00	430	6	52	47	49	45	40	38	33	29	35	31	27	28	22
1.25	495	6	57	51	53	48	45	42	37	34	39	35	31	32	25
1.50	546	6	61	54	57	51	49	45	41	37	42	38	35	35	28
2.00	625	6	66	57	62	55	55	50	46	43	46	42	40	39	32
2.50	676	6	69	60	65	57	59	53	49	46	48	45	43	42	35
3.00	711	7	71	61	67	59	62	55	52	49	50	48	45	44	37
4.00	751	7	74	63	69	60	65	57	54	52	52	50	48	46	39
5.00	773	7	76	64	71	61	67	59	56	54	54	52	50	47	40
10.00	803	9	79	66	73	63	70	65	59	57	56	54	52	49	41

Reflection control L 36/21					
1*3.35 klm					
gamma angle	90°-270°		0°-180°		
	range 1 lx	range 2 lx	luminosity cd/m ²	range 1 lx	range 2 lx
85°	<=2000	<=2000	9652		
75°	<=1000	<=2000	4837		
65°	<=1000	<=2000	3557	<=250	<=1000
55°	<=1000	<=2000	3211	<=500	<=2000
45°	<=2000	<=2000	3457	<=1000	<=2000

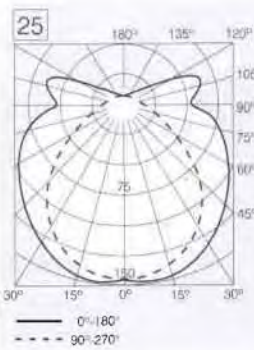

Photo Data 25			Flux CODE 51 83 95 93 64												
Index SPACE K	CIE DDR	CIE RCS	REFLECTIONS												
			873	871	773	771	753	751	731	711	551	531	511	331	000
0.60	354	4	37	34	36	33	28	27	23	20	25	22	19	21	17
0.80	426	4	43	39	41	37	33	32	28	25	30	26	24	25	20
1.00	490	4	47	43	45	41	38	35	31	28	33	30	27	28	23
1.25	553	5	51	46	48	44	42	39	35	32	36	33	31	31	26
1.50	601	5	54	48	52	46	45	42	38	35	39	36	33	34	29
2.00	676	5	59	51	56	49	50	45	42	40	42	40	38	38	32
2.50	724	3	62	53	58	51	53	48	45	43	45	42	40	40	35
3.00	758	5	63	54	60	52	56	50	47	45	46	44	42	42	36
4.00	795	6	66	56	62	54	58	51	49	47	48	46	45	43	38
5.00	815	6	67	57	63	55	60	53	51	49	49	47	46	44	39
10.00	845	8	70	58	65	56	63	58	53	51	51	49	48	46	40

Reflection control L 36/21					
2*3.35 klm					
gamma angle	90°-270°		0°-180°		
	range 1 lx	range 2 lx	luminosity cd/m ²	range 1 lx	range 2 lx
85°	<=500	<=2000	2278		<=500
75°	<=500	<=2000	1992		<=500
65°	<=500	<=2000	2321	<=500	<=2000
55°	<=1000	<=2000	3339	<=500	<=2000
45°	<=2000	<=2000	4492	<=1000	<=2000

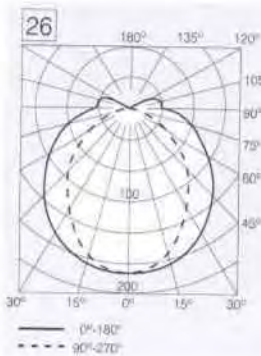

Photo Data 26		Flux CODE 51 83 95 93 64														
Index SPACE K	CIE DDR	CIE RCS	REFLECTIONS													
			873	871	773	771	753	751	731	711	551	531	511	331	000	
0.60	334	5	41	37	39	36	31	29	25	22	28	24	21	24	20	
0.80	423	4	47	43	46	42	38	35	31	28	34	30	27	29	25	
1.00	498	4	53	47	51	46	43	40	36	33	39	35	32	34	29	
1.25	570	4	58	51	54	50	48	44	40	37	43	39	36	38	34	
1.50	624	4	61	54	59	52	52	48	44	41	46	42	40	41	37	
2.00	706	4	66	57	63	56	58	52	49	46	50	47	45	46	42	
2.50	757	3	69	60	66	58	61	55	52	50	53	50	48	49	45	
3.00	793	4	71	61	68	60	64	57	54	52	55	52	51	51	47	
4.00	833	5	74	62	70	61	67	59	57	55	57	55	53	53	49	
5.00	856	5	75	63	72	62	69	60	58	57	58	56	55	54	50	
10.00	900	6	78	65	74	64	72	67	61	60	60	59	58	57	53	

Reflection control L 18/21 4*1.35 klm					
gamma angle	90°-270°		0°-180°		
	range 1 lx	range 2 lx	lumi-nosity cd/m ²	range 1 lx	range 2 lx
85°	<=2000	<=2000	1169	<=1000	<=2000
75°	<=2000	<=2000	1189	<=1000	<=2000
65°	<=2000	<=2000	1457	<=2000	<=2000
55°	<=2000	<=2000	2157	<=1000	<=2000
45°	<=2000	<=2000	2942	<=1000	<=2000

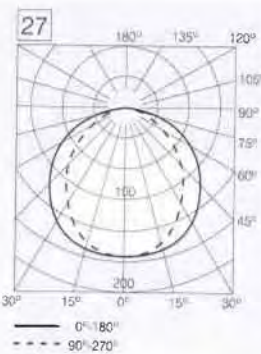

Photo Data 27		Flux CODE 44 76 97 100 59														
Index SPACE K	CIE DDR	CIE RCS	REFLECTIONS													
			873	871	773	771	753	751	731	711	551	531	511	331	000	
0.60	285	5	36	33	35	33	27	26	21	18	25	21	18	21	17	
0.80	367	5	43	39	41	38	33	31	27	23	30	26	23	26	22	
1.00	440	5	48	43	46	42	38	36	31	28	35	31	27	30	26	
1.25	513	5	52	46	49	45	43	40	36	32	39	35	32	34	30	
1.50	572	5	56	49	54	48	47	43	39	36	42	38	35	38	34	
2.00	664	5	61	53	58	52	53	48	44	42	46	44	41	43	39	
2.50	726	3	64	55	62	54	57	51	48	45	50	47	45	46	43	
3.00	771	5	66	57	64	56	59	53	50	48	52	49	48	49	45	
4.00	827	5	69	59	67	58	63	56	54	52	54	53	51	52	49	
5.00	862	5	71	60	68	59	65	57	56	54	56	55	53	53	51	
10.00	936	4	74	62	72	61	70	65	60	59	59	59	58	57	55	

Reflection control L 36/21 2*3.35 klm					
gamma angle	90°-270°		0°-180°		
	range 1 lx	range 2 lx	lumi-nosity cd/m ²	range 1 lx	range 2 lx
85°	<=1000	<=2000	3915	<=250	<=1000
75°	<=250	<=1000	4578	<=250	<=1000
65°	<=1000	<=2000	3925	<=500	<=2000
55°	<=2000	<=2000	3780	<=1000	<=2000
45°	<=2000	<=2000	3837	<=2000	<=2000

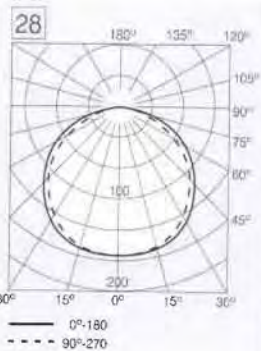

Photo Data 28		Flux CODE 44 76 97 100 59														
Index SPACE K	CIE DDR	CIE RCS	REFLECTIONS													
			873	871	773	771	753	751	731	711	551	531	511	331	000	
0.60	285	5	36	33	35	33	27	26	21	18	25	21	18	21	17	
0.80	367	5	43	39	41	38	33	31	27	23	30	26	23	26	22	
1.00	440	5	48	43	46	42	38	36	31	28	35	31	27	30	26	
1.25	513	5	52	46	49	45	43	40	36	32	39	35	32	34	30	
1.50	572	5	56	49	54	48	47	43	39	36	42	38	35	38	34	
2.00	664	5	61	53	58	52	53	48	44	42	46	44	41	43	39	
2.50	726	3	64	55	62	54	57	51	48	45	50	47	45	46	43	
3.00	771	5	66	57	64	56	59	53	50	48	52	49	48	49	45	
4.00	827	5	69	59	67	58	63	56	54	52	54	53	51	52	49	
5.00	862	5	71	60	68	59	65	57	56	54	56	55	53	53	51	
10.00	936	4	74	62	72	61	70	65	60	59	59	59	58	57	55	

Reflection control L 18/21 4*1.35 klm					
gamma angle	90°-270°		0°-180°		
	range 1 lx	range 2 lx	lumi-nosity cd/m ²	range 1 lx	range 2 lx
85°	<=1000	<=2000	3166	<=500	<=2000
75°	<=250	<=1000	3591	<=250	<=1000
65°	<=1000	<=2000	3088	<=1000	<=2000
55°	<=2000	<=2000	2964	<=2000	<=2000
45°	<=2000	<=2000	3006	<=2000	<=2000

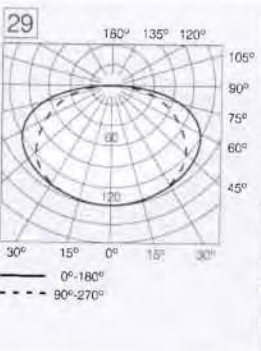
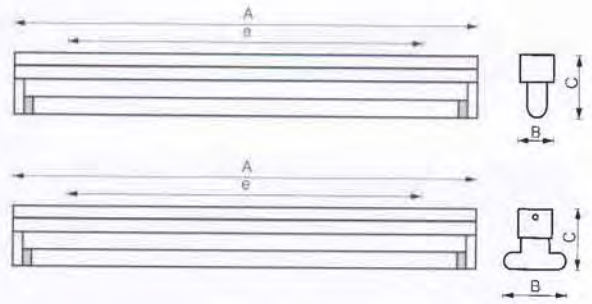

Photo Data 29		Flux CODE 37 67 89 100 47														
Index SPACE K	CIE DDR	CIE RCS	REFLECTIONS													
			873	871	773	771	753	751	731	711	551	531	511	331	000	
0.60	241	7	27	25	26	25	20	19	15	12	18	15	12	15	11	
0.80	316	7	32	29	31	28	24	23	19	16	22	19	16	18	15	
1.00	382	7	36	32	35	32	28	26	22	19	25	22	19	22	18	
1.25	451	7	40	35	37	34	32	29	26	23	29	25	23	25	21	
1.50	507	7	42	37	41	36	35	32	28	25	31	28	25	27	24	
2.00	595	7	46	40	45	39	39	36	33	30	35	32	30	31	28	
2.50	657	7	49	42	47	41	42	38	35	33	37	35	33	34	31	
3.00	703	7	51	44	49	43	45	40	37	35	39	37	35	36	33	
4.00	763	7	53	45	51	45	48	42	40	38	41	39	38	38	36	
5.00	801	7	55	46	53	46	50	44	42	40	43	41	40	40	38	
10.00	889	7	58	49	56	48	54	50	46	45	46	45	44	44	42	

Reflection control 36/21 PL 2*2.9 klm					
gamma angle	90°-270°		0°-180°		
	range 1 lx	range 2 lx	lumi-nosity cd/m ²	range 1 lx	range 2 lx
85°	<=250	<=1000	5999		<=500
75°	<=500	<=2000	4310	<=250	<=1000
65°	<=2000	<=2000	3268	<=1000	<=2000
55°	<=2000	<=2000	2548	<=2000	<=2000
45°	<=2000	<=2000	2369	<=2000	<=2000

5100



A striplight of white colour. The housing is made of pickled steel sheet. It is possible to attach a shade, guard wires or both of them to the lamp in a simple way. Application: production halls, mechanic's workshops, garages...

Tračna svetiljka bele barve. Ohišje iz dekapirane jeklene pločevine. Na svetilko je možno enostavno pritrčiti senčnik, zaščitno mrežo ali oboje. Uporaba: industrijske hale, mehanične delavnice, garaže...

Ленточный светильник белого цвета. Корпус из декапированной листовой стали. Очень просто можно на светильник прикрепить абажур, защитную сетку или же обоё. Применеше: промышленные залы, механические мастерские, гаражи...

Tračna svetiljka bijele boje. Kućište iz dekapiranog čeličnog lima. Na svetiljku je moguće jednostavno pričvrstiti sjenilo, zaštitnu mrežu ili oboje. Upotreba: industrijske hale, mehaničke radionice, garaže...

Code	Art.	W	Photo data	A	B	C	e	kg	dm ³	Price
51001181	5100	1x18	70	622	50	75	440	1.80	2.50	
51001361	5100	1x36	70	1232	50	75	1050	2.40	4.80	
51001581	5100	1x58	70	1537	50	75	1350	2.90	6.00	
52002181	5200	2x18	71	622	100	77	440	2.50	2.50	
52002361	5200	2x36	71	1232	100	77	1050	3.10	4.80	
52002581	5200	2x58	71	1537	100	77	1350	3.70	6.00	

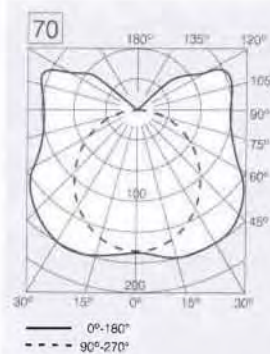

5100 - 1x36		Flux CODE 31 59 81 66 103														
Index SPACE K	CIE DDR	CIE RCS	REFLECTIONS													
			873	871	773	771	753	751	731	711	551	531	511	331	000	
0.60	207	8	54	50	50	47	37	35	28	22	31	25	20	22	14	
0.80	272	8	64	58	59	54	46	43	35	29	38	32	27	28	18	
1.00	332	8	72	65	66	60	53	49	42	36	44	37	32	33	22	
1.25	395	8	79	70	72	66	60	56	48	42	49	43	38	38	27	
1.50	448	8	85	75	78	70	66	60	53	47	54	48	43	42	30	
2.00	530	8	93	81	85	76	75	68	61	55	60	54	50	48	36	
2.50	586	8	98	84	90	79	80	72	66	61	64	59	55	53	40	
3.00	625	8	99	87	93	82	85	75	70	65	67	62	58	55	42	
4.00	672	8	99	90	97	85	90	79	74	70	70	66	63	59	45	
5.00	697	9	99	92	99	86	93	81	77	73	73	69	65	61	47	
10.00	734	-	99	95	99	89	99	90	82	78	76	73	70	64	50	

531 - H(3.00-0.85)m - F1*F2=0.75			
AREA A*B	NUMBER OF LIGHTS REFLECTION		
	120 lx	250 lx	500 lx
10m ²	1.3	2.8	5.6
20m ²	2.2	4.6	9.2
30m ²	3.3	6.8	11.3
50m ²	4.3	8.9	13.4
70m ²	5.6	11.7	23.5
100m ²	8.0	16.7	33.5
150m ²	10.6	22.2	44.7

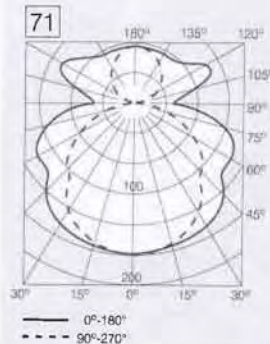

5200 - 2x36		Flux CODE 34 61 85 62 88														
Index SPACE K	CIE DDR	CIE RCS	REFLECTIONS													
			873	871	773	771	753	751	731	711	551	531	511	331	000	
0.60	229	7	47	43	44	41	32	31	25	20	27	22	18	20	12	
0.80	292	7	55	50	51	47	40	38	31	26	33	28	23	24	16	
1.00	353	7	62	56	57	52	46	43	36	31	38	32	28	29	19	
1.25	418	7	68	61	62	57	52	48	42	37	42	37	33	33	23	
1.50	472	7	73	64	67	60	57	52	46	41	46	41	37	36	26	
2.00	557	7	80	69	73	65	65	58	53	48	51	47	43	41	30	
2.50	614	7	84	73	77	68	69	62	57	53	55	51	48	45	33	
3.00	654	7	87	75	80	70	73	65	61	57	57	54	51	47	36	
4.00	699	8	91	77	84	73	77	68	64	61	60	57	54	50	38	
5.00	723	8	93	79	85	74	80	70	66	63	62	59	56	52	39	
10.00	749	-	97	81	89	76	85	77	70	67	64	62	60	54	41	

531 - H(3.00-0.85)m - F1*F2=0.75			
AREA A*B	NUMBER OF LIGHTS REFLECTION		
	120 lx	250 lx	500 lx
10m ²	0.8	1.6	3.2
20m ²	1.3	2.7	5.3
30m ²	1.9	3.9	5.3
50m ²	2.5	5.2	10.3
70m ²	3.2	6.8	13.7
100m ²	4.6	9.8	19.5
150m ²	6.2	12.9	25.9



Code	Art.		W	Photo data	A	B	C	e	kg	dm ³	Price
5101181	5101		1x18	72	622	110	45	440	1.12	5.47	
51011361	5101		1x36	72	1232	110	45	1050	2.10	10.84	
51011581	5101		1x58	72	1537	110	45	1350	2.70	13.53	
52012181	5201		2x18	73	622	170	45	440	1.33	8.46	
52012361	5201		2x36	73	1232	170	45	1050	2.76	16.76	
52012581	5201		2x58	73	1537	170	45	1350	3.90	20.90	
51021181	5102		1x18	74	622	75	105	440	1.10	6.53	
51021361	5102		1x36	74	1232	75	105	1050	1.90	12.94	
51021581	5102		1x58	74	1537	75	105	1350	2.53	16.14	
51041361	5104		1x36	79	1232	170	110	1050	3.02	23.40	
51041581	5104		1x58	79	1535	170	110	1350	4.00	28.70	
52042361	5204		2x36	79	1232	170	110	1050	3.42	23.04	
52042581	5204		2x58	79	1535	170	110	1350	4.88	28.71	
51031361	5103		1x36	70	1232	100	65	1050	1.96	13.55	
51031581	5103		1x58	70	1535	100	65	1350	2.70	16.89	
52032361	5203		2x36	71	1232	170	65	1050	2.56	23.04	
52032581	5203		2x58	71	1535	170	65	1350	3.76	28.71	
50040001	5004		-	-	90	49	24	-	0.10	-	
50070001	5007		-	-	-	-	-	-	0.10	-	

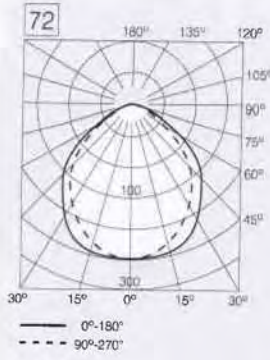

5101 - 1x36 Flux CODE 47 81 97 100 71

Index SPACE K	CIE DDR	CIE RCS	REFLECTIONS															
			873	871	773	771	753	751	731	711	551	531	511	331	000			
0.60	295	5	44	41	43	40	33	32	26	23	31	26	22	26	21			
0.80	387	5	52	47	51	46	41	39	33	29	38	33	29	32	27			
1.00	464	5	58	52	56	51	47	44	39	35	43	38	35	38	33			
1.25	541	5	64	57	61	56	53	49	44	41	48	44	40	43	38			
1.50	598	5	68	60	66	59	58	53	49	45	52	48	45	47	43			
2.00	687	5	74	64	71	63	65	59	55	52	57	54	51	53	49			
2.50	745	3	78	67	75	66	69	62	59	56	61	58	55	57	53			
3.00	785	5	80	69	77	68	72	64	62	59	63	60	58	59	56			
4.00	835	4	83	71	80	70	76	67	65	63	66	64	62	63	59			
5.00	864	4	85	72	82	71	79	69	67	65	68	66	64	65	61			
10.00	928	-	89	75	86	74	84	78	71	70	71	70	69	69	66			

531 - H(3.00-0.85)m - F1*F2=0.75

AREA A*B	NUMBER OF LIGHTS REFLECTION		
	120lx	250lx	500lx
10m ²	1.3	2.7	5.4
20m ²	2.2	4.5	9.0
30m ²	3.4	6.7	13.1
50m ²	4.3	9.0	18.1
70m ²	5.8	12.1	24.1
100m ²	8.2	17.2	34.3
150m ²	11.1	23.2	46.3

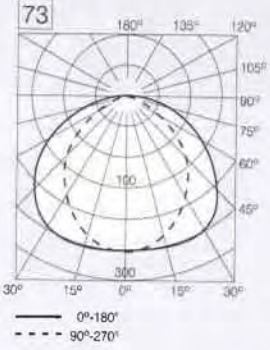

5201 - 2x36 Flux CODE 46 78 96 100 76

Index SPACE K	CIE DDR	CIE RCS	REFLECTIONS															
			873	871	773	771	753	751	731	711	551	531	511	331	000			
0.60	293	5	47	46	46	42	35	34	28	24	33	28	24	27	22			
0.80	379	5	55	50	54	49	43	41	35	31	40	35	31	34	29			
1.00	454	5	62	56	60	54	50	47	41	37	45	40	36	40	34			
1.25	529	5	68	60	64	59	56	52	47	43	51	46	42	45	40			
1.50	587	5	72	64	70	62	61	56	51	47	55	50	47	49	45			
2.00	677	5	79	68	76	67	69	62	58	54	61	57	54	56	51			
2.50	736	3	83	71	80	70	73	66	62	59	64	61	58	60	56			
3.00	779	5	85	73	82	72	77	69	65	63	67	64	62	63	59			
4.00	831	5	89	76	86	75	81	72	69	67	70	68	66	67	63			
5.00	863	5	91	77	88	76	84	74	72	70	72	70	69	69	66			
10.00	932	-	95	80	92	79	90	83	77	76	76	75	74	74	71			

531 - H(3.00-0.85)m - F1*F2=0.75

AREA A*B	NUMBER OF LIGHTS REFLECTION		
	120lx	250lx	500lx
10m ²	0.6	1.3	2.6
20m ²	1.0	2.2	4.3
30m ²	1.6	3.4	6.6
50m ²	2.1	4.3	8.6
70m ²	2.7	5.7	11.4
100m ²	3.9	8.1	16.2
150m ²	5.4	10.9	21.8

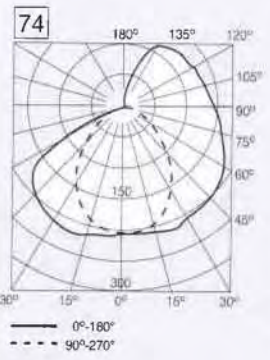

5102 - 1x36 Flux CODE 36 66 87 75 89

Index SPACE K	CIE DDR	CIE RCS	REFLECTIONS															
			873	871	773	771	753	751	731	711	551	531	511	331	000			
0.60	239	7	49	46	47	43	35	33	27	22	30	25	21	23	16			
0.80	312	7	58	53	55	50	43	40	34	28	37	31	27	29	21			
1.00	378	7	65	59	61	56	50	46	40	34	42	37	32	34	25			
1.25	446	7	72	64	66	61	56	52	45	40	48	42	38	39	30			
1.50	500	7	77	68	72	64	61	56	50	45	52	46	42	43	34			
2.00	585	7	84	73	78	69	69	63	57	53	57	53	49	49	39			
2.50	642	7	88	76	83	73	74	67	62	58	61	57	54	53	43			
3.00	682	7	91	79	86	75	78	70	65	61	64	60	57	55	46			
4.00	730	7	95	81	89	78	83	73	69	66	67	64	61	59	49			
5.00	756	7	98	83	91	79	86	75	72	68	69	66	63	61	51			
10.00	799	9	99	85	95	82	91	83	76	73	72	70	67	64	54			

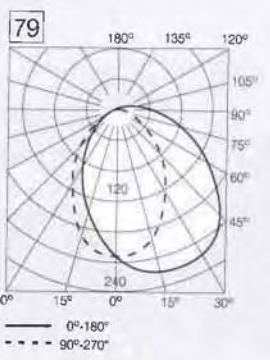

5214 - 2x36 Flux CODE 36 66 87 75 89

Index SPACE K	CIE DDR	CIE RCS	REFLECTIONS															
			873	871	773	771	753	751	731	711	551	531	511	331	000			
0.60	239	7	49	46	47	43	35	33	27	22	30	25	21	23	16			
0.80	312	7	58	53	55	50	43	40	34	28	37	31	27	29	21			
1.00	378	7	65	59	61	56	50	46	40	34	42	37	32	34	25			
1.25	446	7	72	64	66	61	56	52	45	40	48	42	38	39	30			
1.50	500	7	77	68	72	64	61	56	50	45	52	46	42	43	34			
2.00	585	7	84	73	78	69	69	63	57	53	57	53	49	49	39			
2.50	642	7	88	76	83	73	74	67	62	58	61	57	54	53	43			
3.00	682	7	91	79	86	75	78	70	65	61	64	60	57	55	46			
4.00	730	7	95	81	89	78	83	73	69	66	67	64	61	59	49			
5.00	756	7	98	83	91	79	86	75	72	68	69	66	63	61	51			
10.00	799	9	99	85	95	82	91	83	76	73	72	70	67	64	54			

5500



The housing is made of pickled steel sheet, the diffuser of polycarbonate. Art. 5501-complete with the switch, Colour: white, black, red. Application: kitchens, bathrooms, dressingrooms...

Ohišje iz dekapirane jeklene pločevine, difuzor iz polikarbonata. Artikel 5501 ima kao dodatak stikalo. Barva: bela, crna, rdeča. Uporaba: kuhinje, kopalnice, garderobe...

Корпус из декапированной листовой стали, диффузор из поликарбоната. Артикул 5501 содержит прибавленный выключатель. Цвет: белый, чёрный, красный. Применение: кухни, ванные, гардеробы...

Kućište iz dekapiranog čeličnog lima, difuzor iz polikarbonata. Art. 5501 ima kao dodatak prekidač. Boja: bijela, crna, crvena. Upotreba: kuhinje, kupaoznice, garderobe...

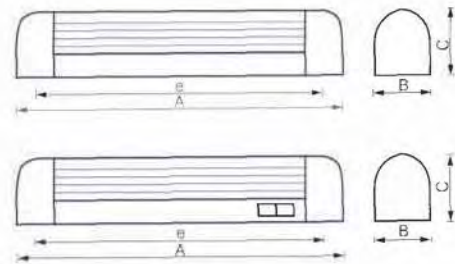

Code	Art.	W	Photo data	A	B	C	e	kg	dm ³	Price
55001181	5500	1x18	75	652	40	80	632	1.2	2.1	
55001361	5500	1x36	75	1252	40	80	1232	1.9	4.0	
55001581	5500	1x58	75	1552	40	80	1532	2.1	5.0	
55011181	5501	1x18	75	652	40	80	632	1.2	2.1	
55011361	5501	1x36	75	1252	40	80	1232	1.9	4.0	
55011581	5501	1x58	75	1552	40	80	1532	2.1	5.0	

5627



The base is of polycarbonate in white colour, the diffuser of printed polymethacrylate. Application: flats, corridors, basements, staircases...

Podnožje iz polikarbonata bele barve, difuzor iz potiskanega polimetakrilata. Uporaba: stanovanja, hodniki, kleti, stopnišča...

Подножие из поликарбоната белого цвета, диффузор из печатного полиметакрилата. Применение: квартиры, коридоры, подвалы, лестницы...

Podnožje iz polikarbonata bijele boje, difuzor iz štampanoga polimetakrilata. Upotreba: stanovi, hodnici, podrumi, stepeništa...

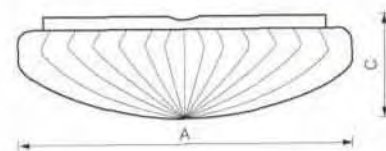

Code	Art.	W	Photo data	Base	A	C	kg	dm ³	Price
56270022	5627	1x22	76	G10c	270	100	1.25	7.0	
56380032	5638	1x32	76	G10c	380	110	1.25	14.0	
56460040	5646	1x40	76	G10c	460	135	1.25	20.0	
56270060	5627	1x60	76	E27	270	110	0.75	7.0	
56380100	5638	1x100	76	E27	380	110	0.85	14.0	
56462600	5646	2x60	76	E27	460	135	0.95	20.0	



5700

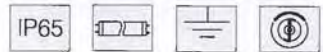
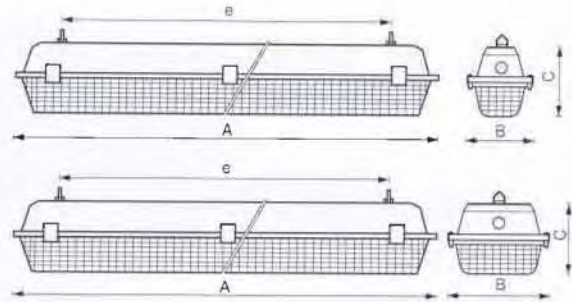

A watertight lamp, the housing is made of resisting glass fibre reinforced polyester light grey. The diffuser is of polycarbonat. Application: damp, dusty and aggressive premises, laboratories, garages...

Vodotesna svetilka. Ohišje iz poliestra ojačanega s steklenimi vlakni, zaščitna kapa iz polikarbonata. Uporaba: vlažni, prašni in agresivni proizvodni prostori, laboratoriji, garaže...

Водонепроницаемый светильник. Корпус из полиэстера упрочнённый с стеклянными волокнами серого цвета, защитный колпачок из поликарбоната. Применение: влажные, пыльные и агрессивные промышленные помещения, лаборатории, гаражи...

Vodootporna svetilka. Kućište iz poliestra ojačanog sa staklenim vlaknima, sive boje, zaštitna kapa iz polikarbonata. Upotreba: vlažni, prašni i agresivni proizvodni prostori, laboratoriji, garaže...

Code	Art.	W	Photo data	A	B	C	e	kg	dm ³	Price
57001181	5700	1x18	77	664	103	120	497	1.8	9.3	
57001361	5700	1x36	77	1280	103	120	997	2.7	17.6	
57001581	5700	1x58	77	1540	103	120	997	3.8	21.7	
57002181	5700	2x18	78	664	160	120	497	2.4	13.9	
57002361	5700	2x36	78	1280	160	120	997	4.4	26.4	
57002581	5700	2x58	78	1540	160	120	997	6.6	32.6	

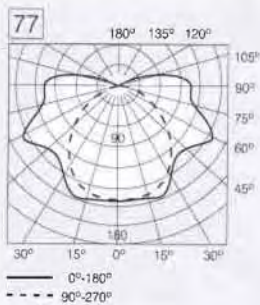

5700 - 1x36		Flux CODE 32 60 82 85 75														
Index SPACE K	CIE DDR	CIE RCS	REFLECTIONS													
			873	871	773	771	753	751	731	711	551	531	511	331	000	
0.60	293	5	47	43	46	42	35	34	28	24	33	28	24	27	22	
0.80	379	5	55	50	54	49	43	41	35	31	40	35	31	34	29	
1.00	454	5	62	56	60	54	50	47	41	37	45	40	36	40	34	
1.25	529	5	68	60	64	59	56	52	47	43	51	46	42	45	40	
1.50	587	5	72	64	70	62	61	56	51	47	55	50	47	49	45	
2.00	677	5	79	68	76	67	69	62	58	54	61	57	54	56	51	
2.50	736	3	83	71	80	70	73	66	62	59	64	61	58	60	56	
3.00	779	5	85	73	82	72	77	69	65	63	67	64	62	63	59	
4.00	831	5	89	76	86	75	81	72	69	67	70	68	66	67	63	
5.00	863	5	91	77	88	76	84	74	72	70	72	70	69	69	66	
10.00	932	4	95	80	92	79	90	83	77	76	76	75	74	74	71	

531 - H(3.00-0.85)m - F1*F2=0.75			
AREA A*B	NUMBER OF LIGHTS REFLECTION		
	120 lx	250 lx	500 lx
10m ²	1.7	3.5	7.0
20m ²	2.8	5.8	11.5
30m ²	3.7	7.7	15.4
50m ²	5.3	11.1	22.1
70m ²	6.9	14.4	28.9
100m ²	9.6	20.0	40.0
150m ²	13.8	28.6	57.3

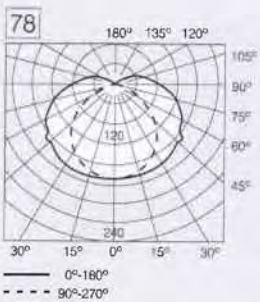

5700 - 2x36		Flux CODE 32 67 87 88 72														
Index SPACE K	CIE DDR	CIE RCS	REFLECTIONS													
			873	871	773	771	753	751	731	711	551	531	511	331	000	
0.60	241	7	41	38	39	36	29	28	22	18	33	28	24	27	22	
0.80	316	7	48	44	46	42	36	34	28	24	40	35	31	34	29	
1.00	382	7	54	48	51	47	41	39	33	29	45	40	36	40	34	
1.25	449	7	59	53	55	51	47	43	38	34	51	46	42	45	40	
1.50	503	7	63	56	60	54	51	47	42	38	55	50	47	49	45	
2.00	587	7	69	60	65	58	58	52	48	44	61	57	54	56	51	
2.50	644	7	73	63	69	61	62	56	52	48	64	61	58	60	56	
3.00	685	7	75	65	71	63	65	58	54	51	67	64	62	63	59	
4.00	737	7	79	67	75	65	69	61	58	55	70	68	66	67	63	
5.00	768	7	81	68	76	66	72	63	60	57	72	70	69	69	66	
10.00	834	8	85	71	80	69	77	71	65	62	76	75	74	74	71	

531 - H(3.00-0.85)m - F1*F2=0.75			
AREA A*B	NUMBER OF LIGHTS REFLECTION		
	120 lx	250 lx	500 lx
10m ²	0.8	1.7	3.3
20m ²	1.3	2.7	5.5
30m ²	1.8	3.7	7.3
50m ²	2.6	5.3	10.7
70m ²	3.4	7.0	14.0
100m ²	4.7	9.7	19.5
150m ²	6.7	14.0	28.0



5800

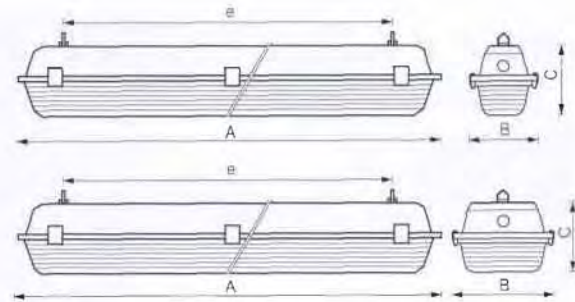

A watertight lamp. The housing is made of polystyrene, the diffuser is of methacrylate. Application: laboratories, damp, dusty and aggressive premises, garages...

Vodotesna svetilka. Ohišje iz polistirola, kapa iz metakrilata. Uporaba: laboratoriji, vlažni, prašni in agresivni proizvodni prostori, garaže...

Водонепроницаемый светильник. Корпус из полистирола, колпачок из метакрилата. Применение: лаборатории, влажные, пыльные и агрессивные производственные помещения, гаражи...

Vodootporna svjetiljka. Kućište iz polistirola, kapa iz metakrilata. Upotreba: laboratoriji, vlažni, prašni i agresivni proizvodni prostori, garaže...

Code	Art.	W	Photo data	A	B	C	e	kg	dm ³	Price
58001181	5800	1x18	77	675	105	115	360	1.20	9.8	
58001361	5800	1x36	77	1258	105	115	645	2.15	18.0	
58001581	5800	1x58	77	1585	105	115	1270	2.90	23.0	
58002181	5800	2x18	78	675	175	115	360	1.90	16.0	
58002361	5800	2x36	78	1258	175	115	645	3.65	30.0	
58002581	5800	2x58	78	1585	175	115	1270	4.90	32.0	

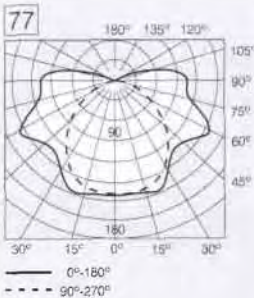

5700 - 1x36		Flux CODE 32 60 82 85 75														
Index SPACE K	CIE DDR	CIE RCS	REFLECTIONS													
			873	871	773	771	753	751	731	711	551	531	511	331	000	
0.60	293	5	47	43	46	42	35	34	28	24	33	28	24	27	22	
0.80	379	5	55	50	54	49	43	41	35	31	40	35	31	34	29	
1.00	454	5	62	56	60	54	50	47	41	37	45	40	36	40	34	
1.25	529	5	68	60	64	59	56	52	47	43	51	46	42	45	40	
1.50	587	5	72	64	70	62	61	56	51	47	55	50	47	49	45	
2.00	677	5	79	68	76	67	69	62	58	54	61	57	54	56	51	
2.50	736	3	83	71	80	70	73	66	62	59	64	61	58	60	56	
3.00	779	5	85	73	82	72	77	69	65	63	67	64	62	63	59	
4.00	831	5	89	76	86	75	81	72	69	67	70	68	66	67	63	
5.00	863	5	91	77	88	76	84	74	72	70	72	70	69	69	66	
10.00	932	4	95	80	92	79	90	83	77	76	76	75	74	74	71	

531 - H(3.00-0.85)m - F1*F2=0.75	
AREA A*B	NUMBER OF LIGHTS REFLECTION
	120 lx 250 lx 500 lx
10m ²	1.7 3.5 7.0
20m ²	2.8 5.8 11.5
30m ²	3.7 7.7 15.4
50m ²	5.3 11.1 22.1
70m ²	6.9 14.4 28.9
100m ²	9.6 20.0 40.0
150m ²	13.8 28.6 57.3

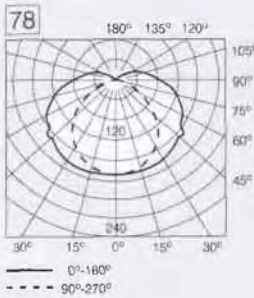

5800 - 2x36		Flux CODE 37 67 87 88 72														
Index SPACE K	CIE DDR	CIE RCS	REFLECTIONS													
			873	871	773	771	753	751	731	711	551	531	511	331	000	
0.60	241	7	41	38	39	36	29	28	22	18	33	28	24	27	22	
0.80	316	7	48	44	46	42	36	34	28	24	40	35	31	34	29	
1.00	382	7	54	48	51	47	41	39	33	29	45	40	36	40	34	
1.25	449	7	59	53	55	51	47	43	38	34	51	46	42	45	40	
1.50	503	7	63	56	60	54	51	47	42	38	55	50	47	49	45	
2.00	587	7	69	60	65	58	58	52	48	44	61	57	54	56	51	
2.50	644	7	73	63	69	61	62	56	52	48	64	61	58	60	56	
3.00	685	7	75	65	71	63	65	58	54	51	67	64	62	63	59	
4.00	737	7	79	67	75	65	69	61	58	55	70	68	66	67	63	
5.00	768	7	81	68	76	66	72	63	60	57	72	70	69	69	66	
10.00	834	8	85	71	80	69	77	67	65	62	76	75	74	74	71	

531 - H(3.00-0.85)m - F1*F2=0.75	
AREA A*B	NUMBER OF LIGHTS REFLECTION
	120 lx 250 lx 500 lx
10m ²	0.8 1.7 3.3
20m ²	1.3 2.7 5.5
30m ²	1.8 3.7 7.3
50m ²	2.6 5.3 10.7
70m ²	3.4 7.0 14.0
100m ²	4.7 9.7 19.5
150m ²	6.7 14.0 28.0



5900

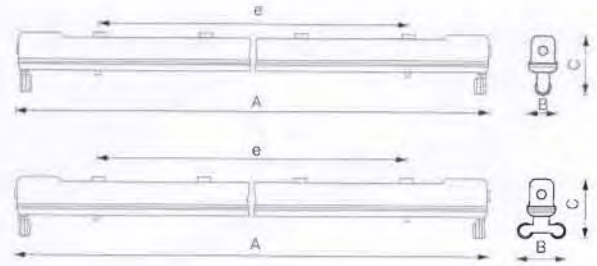

A watertight striplight with the housing made of resisting glass fibre reinforced polyester light grey. Application: laboratories, damp, dusty and acid aggressive premisses, garages.

Vodotesna tračna svetilka. Ohišje iz poliestra ojačanega s steklenimi vlakni sive barve. Uporaba: vlažni, prašni in agresivni proizvodni prostori, laboratoriji, garaže.

Водонепроницаемый светильник. Корпус из полиэстера упрочнённый с стеклянными волокнами серого цвета. Применение: влажные, пыльные и агрессивные промышленные помещения, лаборатории, гаражи.

Vodootporna tračna svetilka. Kućište iz poliestra ojačanog sa staklenim vlaknima sive boje. Upotreba: vlažni, prašni i agresivni proizvodni prostori, laboratoriji, garaže.

Code	Art	W	Photo data	A	B	C	e	kg	dm ³	Price
59001181	5900	1x18	70	646	65	124	500	1.8	6.5	
59001361	5900	1x36	70	1257	65	124	800	2.3	12.2	
59001581	5900	1x58	70	1557	65	124	1200	3.0	15.0	
59002181	5900	2x18	71	646	126	124	500	3.0	6.5	
59002361	5900	2x36	71	1257	126	124	800	3.8	12.0	
59002581	5900	2x58	71	1557	126	124	1200	4.8	15.0	

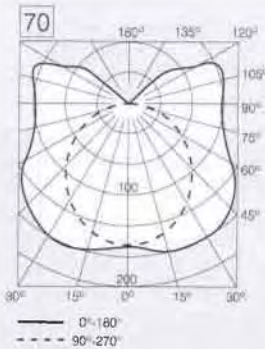

5900 - 1x36			Flux CODE 31 59 81 66 103																						
Index SPACE K	CIE DDR	CIE RCS	REFLECTIONS																						
			873	871	773	771	753	751	731	711	551	531	511	331	000										
0.60	207	8	54	50	50	47	37	35	28	22	31	25	20	22	14										
0.80	272	8	64	58	59	54	46	43	35	29	38	32	27	28	18										
1.00	332	8	72	65	66	60	53	49	42	36	44	37	32	33	22										
1.25	395	8	79	70	72	66	60	56	48	42	49	43	38	38	27										
1.50	448	8	85	75	78	70	66	60	53	47	54	48	43	42	30										
2.00	530	8	93	81	85	76	75	68	61	55	60	54	50	48	36										
2.50	586	8	98	84	90	79	80	72	66	61	64	59	55	53	40										
3.00	625	8	99	87	93	82	85	75	70	65	67	62	58	55	42										
4.00	672	8	99	90	97	85	90	79	74	70	70	66	63	59	45										
5.00	697	9	99	92	99	86	93	81	77	73	73	69	65	61	47										
10.00	734	-	99	95	99	89	99	90	82	78	76	73	70	64	50										

531 - H(3 00-0.85)m - F1*F2=0.75			
AREA A*B	NUMBER OF LIGHTS REFLECTION		
	120 lx	250 lx	500 lx
10m ²	1.3	2.8	5.6
20m ²	2.2	4.6	9.2
30m ²	3.3	6.8	11.3
50m ²	4.3	8.9	13.4
70m ²	5.6	11.7	23.5
100m ²	8.0	16.7	33.5
150m ²	10.6	22.2	44.7

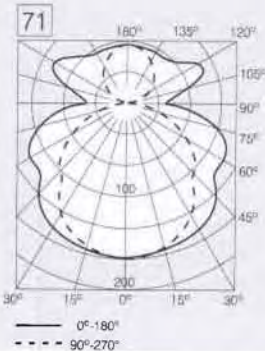

5900 - 2x36			Flux CODE 34 61 85 62 88																						
Index SPACE K	CIE DDR	CIE RCS	REFLECTIONS																						
			873	871	773	771	753	751	731	711	551	531	511	331	000										
0.60	229	7	47	43	44	41	32	31	25	20	27	22	18	20	12										
0.80	292	7	55	50	51	47	40	38	31	26	33	28	23	24	16										
1.00	353	7	62	56	57	52	46	43	36	31	38	32	28	29	19										
1.25	418	7	68	61	62	57	52	48	42	37	42	37	33	33	23										
1.50	472	7	73	64	67	60	57	52	46	41	46	41	37	36	26										
2.00	557	7	80	69	73	65	65	58	53	48	51	47	43	41	30										
2.50	614	7	84	73	77	68	69	62	57	53	55	51	48	45	33										
3.00	654	7	87	75	80	70	73	65	61	57	57	54	51	47	36										
4.00	699	8	91	77	84	73	77	68	64	61	60	57	54	50	38										
5.00	723	8	93	79	85	74	80	70	66	63	62	59	56	52	39										
10.00	749	-	97	81	89	76	85	77	70	67	64	62	60	54	41										

531 - H(3 00-0.85)m - F1*F2=0.75			
AREA A*B	NUMBER OF LIGHTS REFLECTION		
	120 lx	250 lx	500 lx
10m ²	0.8	1.6	3.2
20m ²	1.3	2.7	5.3
30m ²	1.9	3.9	5.3
50m ²	2.5	5.2	10.3
70m ²	3.2	6.8	13.7
100m ²	4.6	9.8	19.5
150m ²	6.2	12.9	25.9



Code	Art.	W	Photo data	A	B	C	e	kg	dm ³	Price
59011361	5901		1x36	72	1258	110	124	800	3.0	20.6
59011581	5901		1x58	72	1585	110	124	1200	3.7	25.0
59012361	5901		2x36	73	1258	170	124	800	3.1	32.0
59012581	5901		2x58	73	1585	170	124	1200	5.6	40.0
59031361	5903		1x36	70(2)	1258	110	108	800	2.8	15.0
59031581	5903		1x58	70(2)	1585	110	108	1200	3.8	19.0
59032361	5903		2x36	71(3)	1258	170	108	800	4.6	23.0
59032581	5903		2x58	71(3)	1585	170	108	1200	5.6	29.0

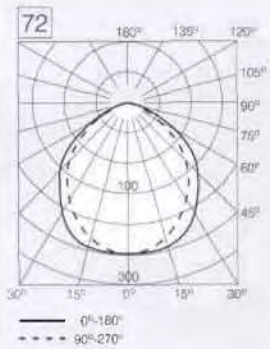

5901 - 1x36			Flux CODE 34 61 85 62 88																						
Index SPACE K	CIE DDR	CIE RCS	REFLECTIONS																						
			873	871	773	771	753	751	731	711	551	531	511	331	000										
0.60	229	7	47	43	44	41	32	31	25	20	27	22	18	20	12										
0.80	292	7	55	50	51	47	40	38	31	26	33	28	23	24	16										
1.00	353	7	62	56	57	52	46	43	36	31	38	32	28	29	19										
1.25	418	7	68	61	62	57	52	46	42	37	42	37	33	33	23										
1.50	472	7	73	64	67	60	57	52	46	41	46	41	37	36	26										
2.00	557	7	80	69	73	65	65	58	53	48	51	47	43	41	30										
2.50	614	7	84	73	77	68	69	62	57	53	55	51	48	45	33										
3.00	654	7	87	75	80	70	73	65	61	57	57	54	51	47	36										
4.00	699	8	91	77	84	73	77	68	64	61	60	57	54	50	38										
5.00	723	8	93	79	85	74	80	70	66	63	62	59	56	52	39										
10.00	749	-	97	81	89	76	85	77	70	67	64	62	60	54	41										

531 - H(3.00-0.85)m - F1*F2=0.75			
AREA A*B	NUMBER OF LIGHTS REFLECTION		
	120 lx	250 lx	500 lx
10m ²	1.3	2.7	5.4
20m ²	2.2	4.5	9.0
30m ²	3.4	6.7	13.1
50m ²	4.3	9.0	18.1
70m ²	5.8	12.1	24.1
100m ²	8.2	17.2	34.3
150m ²	11.1	23.2	46.3

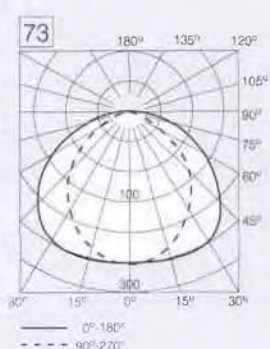

5901 - 2x36			Flux CODE 46 78 96 100 76																						
Index SPACE K	CIE DDR	CIE RCS	REFLECTIONS																						
			873	871	773	771	753	751	731	711	551	531	511	331	000										
0.60	293	5	47	46	46	42	35	34	28	24	33	28	24	27	22										
0.80	379	5	55	50	54	49	43	41	35	31	40	35	31	34	29										
1.00	454	5	62	56	60	54	50	47	41	37	45	40	36	40	34										
1.25	529	5	68	60	64	59	56	52	47	43	51	46	42	45	40										
1.50	587	5	72	64	70	62	61	56	51	47	55	50	47	49	45										
2.00	677	5	79	68	76	67	69	62	58	54	61	57	54	56	51										
2.50	736	3	83	71	80	70	73	66	62	59	64	61	58	60	56										
3.00	779	5	85	73	82	72	77	69	65	63	67	64	62	63	59										
4.00	831	5	89	76	86	75	81	72	69	67	70	68	66	67	63										
5.00	863	5	91	77	88	76	84	74	72	70	72	70	69	69	66										
10.00	932	4	95	80	92	79	90	83	77	76	76	75	74	74	71										

531 - H(3.00-0.85)m - F1*F2=0.75			
AREA A*B	NUMBER OF LIGHTS REFLECTION		
	120 lx	250 lx	500 lx
10m ²	0.6	1.3	2.6
20m ²	1.0	2.2	4.3
30m ²	1.6	3.4	6.6
50m ²	2.1	4.3	8.6
70m ²	2.7	5.7	11.4
100m ²	3.9	8.1	16.2
150m ²	5.4	10.9	21.8

6200

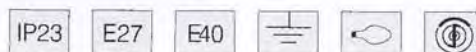
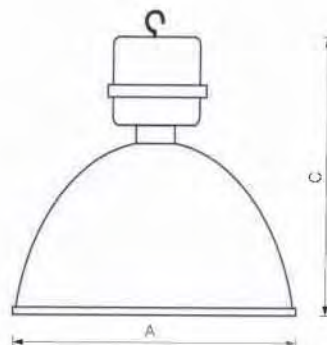

An industrial floodlight complete with the hanger for industrial application. The housing made of die-cast aluminium in black colour, the reflector of 99.85% anodized aluminium. The lamp socket E27 or E40 allows adjustment of the bulb (beam of light). The protective glass is supplied separately. Application: sport halls, production halls, storerooms, interior heights more than 5 m.

Industrijski reflektor z obešalom. Ohišje iz brizganega aluminija črne barve, reflektor iz 99.85% aluminija, anodiziran. Grlo E27 ali E40 omogoča nastavitve žarnice (svetlobnega snopa). Zaščitno steklo dobavljamo posebej. Uporaba: športne dvorane, industrijske hale, skladišča, notranje višine nad 5 metrov.

Промышленный рефлектор с устройством для вешания. Корпус из разбрызганного алюминия чёрного цвета, рефлектор из 99.85% алюминия, анодизированный. Патрон E27 или E40 осуществляет наставку лампочки (светового пучка). Защитное стекло доставляем отдельно. Применение: спортивные дворцы, промышленные залы, склады внутренней высоты больше 5м.

Industrijski reflektor sa vješalicom. Kućište iz brizganog aluminija crne boje, reflektor iz 99.85% aluminija, anodiziran. Grlo E27 ili E40 omogućava podešavanje žarulje (svjetlosnog snopa). Zaštitno staklo isporučujemo posebno. Upotreba: sportske dvorane, industrijske hale, skladišta, unutrašnje visine nad 5 metara.

Code	Art	W	Photo data	A	C	kg	dm ³	Price
61000000	6100 - E27	≤ 200	-	340	460	2.5	53.0	
61000076	6100 - 70 NAV	70	60	340	460	2.5	53.0	
61000127	6100 - 125 HQL	125	60	340	460	2.8	53.0	
62000000	6200 - E40	≤ 500	-	490	590	5.5	141.0	
62000257	6200 - 250 HQL	250	61	490	590	6.8	141.0	
62000255	6200 - 250 HQL	250	61	490	590	6.8	141.0	
62000256	6200 - 250 NAV	250	61	490	590	6.8	141.0	
62000407	6200 - 400 HQL	400	62	490	590	7.8	141.0	
62000405	6200 - 400 HQL	400	62	490	590	7.8	141.0	
62000406	6200 - 400 NAV	400	62	490	590	7.9	141.0	
61011000	6101 - glass	-	-	340	5	1.3	0.6	
62011000	6201 - glass	-	-	490	5	1.4	1.2	

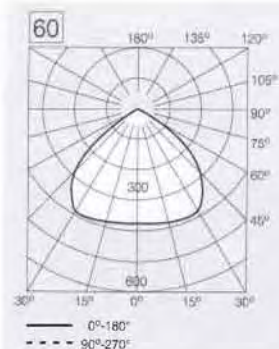

6100 - 70 NAV			Flux CODE 72 98 100 100 78															
Index SPACE K	CIE DDR	CIE RCS	REFLECTIONS															
			873	871	773	771	753	751	731	711	551	531	511	331	000			
0.60	.489	2	60	55	58	54	49	47	43	40	47	43	40	42	.38			
0.80	.578	2	68	62	66	61	58	54	50	47	54	50	47	49	45			
1.00	.652	1	74	66	72	66	64	60	56	53	59	55	53	55	51			
1.25	.717	1	79	70	76	70	70	65	61	58	64	61	58	60	56			
1.50	.763	1	83	73	81	72	74	68	65	62	67	64	62	63	60			
2.00	.831	1	88	77	86	76	80	73	70	68	71	69	67	68	65			
2.50	.870	1	91	79	89	78	84	75	73	71	74	72	71	71	68			
3.00	.897	1	93	80	91	79	87	77	75	74	76	74	73	73	70			
4.00	.922	1	96	81	93	81	89	79	78	76	77	76	75	75	72			
5.00	.936	1	97	82	94	81	91	80	79	78	78	77	76	76	73			
10.00	.963	1	99	84	96	83	95	87	81	80	80	80	79	78	75			

531-H(5.00-0.85)m-F1*F2=0.75			
AREA A*B	NUMBER OF LIGHTS REFLECTION		
	120 lx	250 lx	500 lx
30m ²	1.7	3.5	6.9
50m ²	2.5	5.2	10.5
70m ²	3.3	6.8	13.6
100m ²	4.4	9.2	18.3
150m ²	6.3	13.2	26.4
300m ²	11.6	24.2	48.4
500m ²	18.7	39.0	78.0

6100 - 125 HQL			
531-H(5.00-0.85)m-F1*F2=0.75			
AREA A*B	NUMBER OF LIGHTS REFLECTION		
	120 lx	250 lx	500 lx
30m ²	1.5	3.1	6.1
50m ²	2.2	4.7	9.3
70m ²	2.9	6.0	12.1
100m ²	3.9	8.2	16.3
150m ²	5.6	11.7	23.4
300m ²	10.3	21.5	43.0
500m ²	16.6	34.7	69.3



61

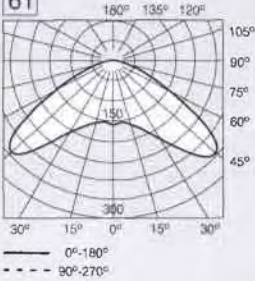

6200 - 250 HQL										Flux CODE 36 86 99 100 96									
Index SPACE K	CIE DDR	CIE RCS	REFLECTIONS																
			873	871	773	771	753	751	731	711	551	531	511	331	000				
0.60	.186	8	52	48	51	47	36	34	26	20	33	26	20	25	18				
0.80	.311	7	66	60	64	58	50	47	39	33	45	38	32	37	30				
1.00	.409	6	76	68	73	66	60	56	48	42	54	47	42	47	39				
1.25	.505	6	85	75	80	74	70	64	57	52	63	56	52	56	49				
1.50	.575	5	91	80	88	79	77	71	64	59	69	63	58	62	56				
2.00	.676	5	99	87	96	85	87	79	74	69	77	72	68	71	65				
2.50	.736	3	99	91	99	89	93	84	79	75	82	78	74	76	71				
3.00	.777	5	99	93	99	92	98	87	83	80	85	81	78	80	75				
4.00	.825	5	99	96	99	95	99	91	88	85	89	86	83	84	80				
5.00	.852	5	99	98	99	96	99	93	90	88	91	88	86	87	82				
0.00	.909	6	99	99	99	99	99	99	96	94	95	94	92	92	88				

AREA A*B	NUMBER OF LIGHTS REFLECTION		
	120 lx	250 lx	500 lx
	30m ²	0.7	1.5
50m ²	1.0	2.0	4.0
70m ²	1.2	2.5	4.9
100m ²	1.5	3.1	6.3
150m ²	2.1	4.3	8.7
300m ²	3.6	7.5	15.1
500m ²	5.7	11.9	23.8

6200 - 250 HQL

AREA A*B	NUMBER OF LIGHTS REFLECTION		
	120 lx	250 lx	500 lx
	30m ²	0.9	1.9
50m ²	1.3	2.6	5.3
70m ²	1.5	3.2	6.4
100m ²	2.0	4.1	8.2
150m ²	2.7	5.7	11.3
300m ²	4.7	9.9	19.7
500m ²	7.5	15.6	31.1

6200 - 250 NAV

AREA A*B	NUMBER OF LIGHTS REFLECTION		
	120 lx	250 lx	500 lx
	30m ²	0.5	1.0
50m ²	0.7	1.4	2.7
70m ²	0.8	1.7	3.4
100m ²	1.0	2.1	4.3
150m ²	1.4	2.9	5.9
300m ²	2.5	5.1	10.3
500m ²	3.9	8.1	16.2

62

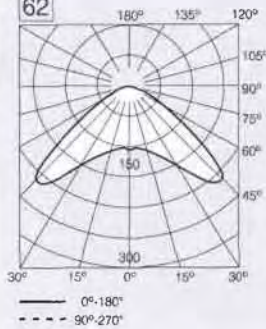

6200 - 400 HQL										Flux CODE 33 80 99 100 80									
Index SPACE K	CIE DDR	CIE RCS	REFLECTIONS																
			873	871	773	771	753	751	731	711	551	531	511	331	000				
0.60	.175	9	43	39	41	38	29	28	21	16	27	20	16	20	14				
0.80	.288	7	54	49	52	47	40	37	30	25	36	30	25	29	23				
1.00	.380	7	61	55	59	54	48	45	38	33	43	37	33	37	30				
1.25	.473	6	69	61	65	60	56	52	45	41	50	45	40	44	38				
1.50	.543	6	74	65	71	64	62	57	51	46	55	50	46	49	43				
2.00	.647	6	82	71	79	70	71	64	59	55	62	58	54	57	52				
2.50	.713	5	86	74	83	73	76	68	64	61	67	63	60	62	57				
3.00	.759	5	89	77	86	75	80	71	68	65	69	66	64	65	61				
4.00	.815	5	93	79	90	78	85	75	72	69	73	71	68	69	65				
5.00	.849	5	96	81	92	80	88	77	75	73	75	73	71	72	68				
10.00	.918	5	99	84	96	83	94	87	80	79	79	78	77	77	74				

AREA A*B	NUMBER OF LIGHTS REFLECTION		
	120 lx	250 lx	500 lx
	30m ²	0.5	1.0
50m ²	0.7	1.4	2.8
70m ²	0.8	1.7	3.4
100m ²	1.0	2.2	4.3
150m ²	1.4	3.0	6.0
300m ²	2.4	5.1	10.2
500m ²	3.8	8.0	16.0

6200 - 400 HQL

AREA A*B	NUMBER OF LIGHTS REFLECTION		
	120 lx	250 lx	500 lx
	30m ²	0.7	1.4
50m ²	1.0	2.0	4.0
70m ²	1.2	2.4	4.8
100m ²	1.5	3.1	6.1
150m ²	2.0	4.2	8.4
300m ²	3.5	7.2	14.4
500m ²	5.4	11.3	22.5

200 - 400 NAV

AREA A*B	NUMBER OF LIGHTS REFLECTION		
	120 lx	250 lx	500 lx
	30m ²	0.3	0.7
50m ²	0.4	0.9	1.9
70m ²	0.5	1.1	2.3
100m ²	0.7	1.4	2.9
150m ²	0.9	2.0	3.9
300m ²	1.6	3.4	6.7
500m ²	2.5	5.3	10.5

6300

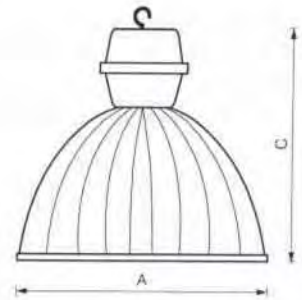

An industrial floodlight complete with the hanger and tempered protective glass. The housing is made of die-cast aluminium in black colour, the reflector of 99.85% polished and anodized aluminium. The lamp socket E40 allows adjustment of the bulb (beam of light). Application: sport halls, production halls, store-rooms, interior heights more than 5 m.

Industrijski reflektor z obešalom in kaljenim zaščitnim steklom. Ohišje iz briganega aluminija črne barve, reflektor iz 99.85% aluminija, poliran in anodiziran. Grič E40 omogoča nastavitve žarnice (svetlobnega snopa). Uporaba: športne dvorane, industrijske hale, skladišča, notranje višine nad 5 metrov.

Промышленный рефлектор с устройством для вешания и раскалённым стеклом. Корпус из разбрызганного алюминия чёрного цвета, рефлектор из 99.85% алюминия, полированный и анодизированный. Патрон E40 осуществляет наставку лампочки (светового пучка). Применение: спортивные дворцы, промышленные залы, склады, внутренней высоты больше 5 м.

Industrijski reflektor sa vješalom i vatrostalnim zaštitnim staklom. Kućište iz briganog aluminija crne boje, reflektor iz 99.85% aluminija, poliran i anodiziran. Grič E40 omogućava nastavljanje žarulje (svjetlosnog snopa). Upotreba: sportske dvorane, industrijske hale, skladišta, unutrašnje visine nad 5 metara.

Code	Art.	W	Photo data	A	C	kg	dm ³	Price
63000257	6300 - 250 HQL	250	63	497	510	7.9	26	
63000255	6300 - 250 HQI	250	63	497	510	7.9	26	
63000256	6300 - 250 NAV	250	63	497	510	8.0	26	
63000407	6300 - 400 HQL	400	64	497	510	8.9	26	
63000405	6300 - 400 HQI	400	64	497	510	8.9	26	
63000406	6300 - 400 NAV	400	64	497	510	8.9	26	

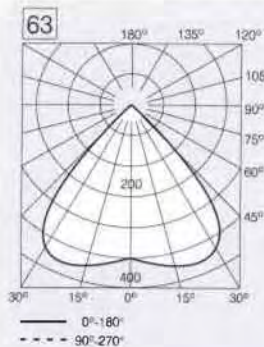

6300 - 250 HQI		Flux CODE 80 100 100 100 71														
Index SPACE K	CIE DDR	CIE RCS	REFLECTIONS													
			873	871	773	771	753	751	731	711	551	531	511	331	000	
0.60	552	1	57	53	56	52	49	47	43	40	46	43	40	42	39	
0.80	633	1	64	58	63	57	55	52	49	46	52	49	46	48	45	
1.00	701	-	69	62	68	61	61	57	54	51	56	53	51	53	50	
1.25	760	-	74	65	70	65	66	61	58	56	60	57	55	57	54	
1.50	800	-	77	68	75	67	69	63	61	59	63	60	58	60	57	
2.00	862	-	81	71	79	70	74	67	65	64	66	64	63	64	61	
2.50	897	-	84	72	81	71	77	69	68	66	68	67	66	66	64	
3.00	921	-	85	73	83	72	80	71	70	68	70	69	68	68	65	
4.00	942	-	87	74	85	74	82	72	71	70	71	70	69	69	67	
5.00	953	-	89	75	86	74	83	73	72	71	72	71	70	70	68	
0.00	975	-	91	76	88	75	86	80	74	73	73	72	71	69		

AREA A*B	NUMBER OF LIGHTS REFLECTION		
	120 lx	250 lx	500 lx
30m ²	0.6	1.2	2.4
50m ²	0.9	1.8	3.6
70m ²	1.1	2.4	4.8
100m ²	1.6	3.3	6.5
150m ²	2.3	4.7	9.4
300m ²	4.2	8.8	17.6
500m ²	6.8	14.2	28.4

AREA A*B	NUMBER OF LIGHTS REFLECTION		
	120 lx	250 lx	500 lx
30m ²	0.7	1.5	3.1
50m ²	1.1	2.4	4.8
70m ²	1.5	3.1	6.2
100m ²	2.0	4.3	8.5
150m ²	3.0	6.2	12.3
300m ²	5.5	11.5	23.0
500m ²	8.9	18.6	37.2

AREA A*B	NUMBER OF LIGHTS REFLECTION		
	120 lx	250 lx	500 lx
30m ²	0.4	0.8	1.6
50m ²	0.6	1.2	2.5
70m ²	0.8	1.6	3.2
100m ²	1.1	2.2	4.4
150m ²	1.5	3.2	6.4
300m ²	2.9	6.0	11.9
500m ²	4.6	9.7	19.3



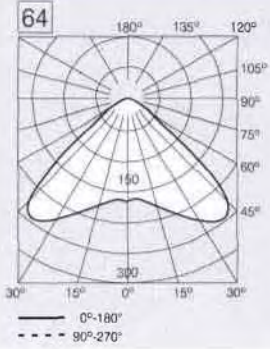

6300 - 400 HQI			Flux CODE 51 97 100 100 71														
Index SPACE K	CIE DDR	CIE RCS	REFLECTIONS														
			873	871	773	771	753	751	731	711	551	531	511	331	000		
0.60	294	5	44	41	43	40	33	32	26	22	31	26	22	26	21		
0.80	421	4	54	49	52	48	43	41	36	32	40	35	32	35	30		
1.00	518	4	61	55	59	54	50	47	42	39	46	42	39	41	37		
1.25	609	3	67	60	64	59	57	53	49	45	52	48	45	47	43		
1.50	671	3	71	63	69	62	62	57	53	50	56	52	50	52	48		
2.00	759	3	77	67	75	66	69	62	59	57	61	58	56	57	54		
2.50	807	3	80	69	78	68	73	65	63	60	64	62	60	61	57		
3.00	838	3	82	71	80	70	75	67	65	63	66	64	62	63	60		
4.00	870	3	85	72	82	71	78	69	67	65	68	66	65	65	62		
5.00	887	3	86	73	83	72	80	70	68	67	69	67	66	66	63		
0.00	920	5	89	74	86	74	84	77	71	70	71	70	69	68	65		

531 - H(5.00-0.85)m - F1*F2=0.75			
AREA A*B	NUMBER OF LIGHTS REFLECTION		
	120 lx	250 lx	500 lx
30m ²	0.4	0.9	1.7
50m ²	0.6	1.3	2.5
70m ²	0.8	1.6	3.1
100m ²	1.0	2.1	4.1
150m ²	1.4	2.9	5.8
300m ²	2.5	5.2	10.5
500m ²	4.0	8.4	16.7

6300 - 400 HQL			
531 - H(5.00-0.85)m - F1*F2=0.75			
AREA A*B	NUMBER OF LIGHTS REFLECTION		
	120 lx	250 lx	500 lx
30m ²	0.6	1.2	2.5
50m ²	0.9	1.8	3.5
70m ²	1.1	2.2	4.4
100m ²	1.4	2.9	5.8
150m ²	2.0	4.1	8.2
300m ²	3.5	7.4	14.7
500m ²	5.7	11.8	23.6

6300 - 400 NAV			
531 - H(5.00-0.85)m - F1*F2=0.75			
AREA A*B	NUMBER OF LIGHTS REFLECTION		
	120 lx	250 lx	500 lx
30m ²	0.3	0.6	1.2
50m ²	0.4	0.8	1.7
70m ²	0.5	1.0	2.1
100m ²	0.6	1.4	2.7
150m ²	0.9	1.9	3.8
300m ²	1.7	3.4	6.9
500m ²	2.7	5.5	11.0

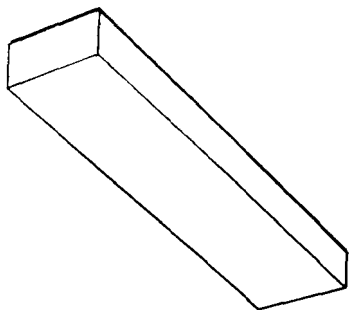

Слика Д.1

Опис: Светилка за надградба со ниска носечка плоча и со опална капа, со две флуоресцентни сијалици. Сијалиците можат да бидат со моќност 20(18), 40(36) или 65(58) W при што должината на светилката е 0,66 m, 1,27 m или 1,57 m, соодветно.

Намена: За суви простории со мали или средни светлотехнички барања.

Индекс на просторија	Коефициент на искористување на осветлението [54]							
	ρ_1	0,8	0,7	0,7	0,5	0,5	0,3	0,0
	ρ_3	0,7	0,5	0,5	0,5	0,3	0,3	0,0
	ρ_4	0,3	0,3	0,1	0,1	0,1	0,1	0,0
0,60	0,35	0,25	0,24	0,22	0,18	0,17	0,12	
0,80	0,42	0,31	0,29	0,27	0,23	0,21	0,16	
1,00	0,47	0,36	0,33	0,31	0,27	0,25	0,19	
1,25	0,51	0,40	0,37	0,34	0,31	0,28	0,22	
1,50	0,55	0,44	0,41	0,37	0,34	0,31	0,25	
2,00	0,60	0,50	0,45	0,41	0,38	0,35	0,29	
2,50	0,63	0,53	0,48	0,44	0,41	0,38	0,32	
3,00	0,65	0,56	0,50	0,46	0,43	0,40	0,34	
4,00	0,68	0,59	0,52	0,48	0,46	0,42	0,36	
5,00	0,70	0,61	0,54	0,50	0,47	0,44	0,37	

Нечистотија	Фактор на нечистотија, f_1 [54]		
	Период на чистење - години		
	Една	Две	Три
Мала	0,93	0,88	0,86
Нормална	0,83	0,77	0,72
Голема	0,72	0,64	0,59

Број и моќност на флуоресцентни сијалици	Флукс-кодови [54]				
	N_1	N_2	N_3	N_4	N_5
2x40(36) W	0,38	0,68	0,88	0,76	0,63

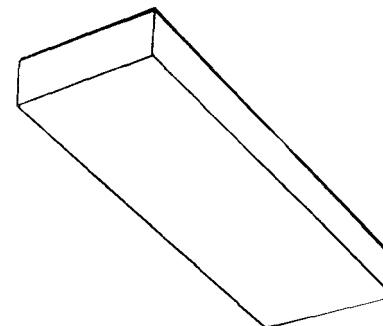

Слика Д.2

Опис: Светилка за надградба со ниска носечка плоча и со опална капа, со три флуоресцентни сијалици. Сијалиците можат да бидат со моќност 20(18), 40(36) или 65(58) W, при што должината на светилката е 0,66 m, 1,27 m или 1,57 m, соодветно.

Намена: За суви простории со мали или средни светлотехнички барања.

Индекс на просторија	Коефициент на искористување на осветлението [54]							
	ρ_1	0,8	0,7	0,7	0,5	0,5	0,3	0,0
	ρ_3	0,7	0,5	0,5	0,5	0,3	0,3	0,0
	ρ_4	0,3	0,3	0,1	0,1	0,1	0,1	0,0
0,60	0,32	0,23	0,22	0,20	0,17	0,16	0,12	
0,80	0,38	0,28	0,27	0,25	0,21	0,20	0,15	
1,00	0,42	0,33	0,30	0,28	0,24	0,23	0,18	
1,25	0,46	0,37	0,34	0,32	0,28	0,26	0,21	
1,50	0,50	0,40	0,37	0,34	0,31	0,29	0,23	
2,00	0,54	0,45	0,41	0,38	0,35	0,33	0,27	
2,50	0,57	0,48	0,43	0,40	0,38	0,35	0,30	
3,00	0,59	0,51	0,45	0,42	0,40	0,37	0,32	
4,00	0,61	0,54	0,47	0,44	0,42	0,39	0,34	
5,00	0,63	0,56	0,49	0,45	0,44	0,41	0,35	

Нечистотија	Фактор на нечистотија, f_1 [54]		
	Период на чистење - години		
	Една	Две	Три
Мала	0,93	0,88	0,86
Нормална	0,83	0,77	0,72
Голема	0,72	0,64	0,59

Број и моќност на флуоресцентни сијалици	Флукс-кодови [54]				
	N_1	N_2	N_3	N_4	N_5
3x40(36) W	0,39	0,69	0,89	0,79	0,56

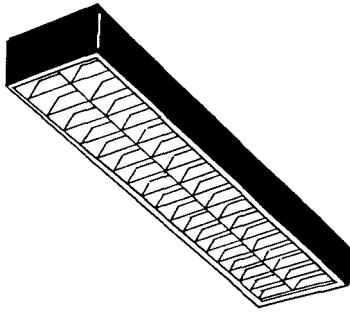

Слика Д.3

Опис: Светилка за надградба со куќиште и бел V-растер, со две флуоресцентни сијалици. Сијалиците можат да бидат со моќност 20(18), (36) или 65(58) W, при што, должината на светилката е 0,646 m, 1,267 m или 1,567 m, соодветно.

Намена: За суви простории со средни или големи светлотехнички барања, каде дополнително се бара ограничување на блескотење.

Индекс на просторија	Коефициент на искористување на осветлението [54]							
	ρ_1	0,8	0,7	0,7	0,5	0,5	0,3	0,0
	ρ_3	0,7	0,5	0,5	0,5	0,3	0,3	0,0
	ρ_4	0,3	0,3	0,1	0,1	0,1	0,1	0,0
0,60	0,35	0,28	0,27	0,26	0,23	0,23	0,20	
0,80	0,40	0,33	0,31	0,31	0,28	0,27	0,24	
1,00	0,44	0,37	0,35	0,34	0,31	0,31	0,28	
1,25	0,48	0,41	0,38	0,37	0,35	0,34	0,31	
1,50	0,50	0,44	0,40	0,39	0,37	0,37	0,34	
2,00	0,54	0,48	0,44	0,43	0,41	0,40	0,37	
2,50	0,56	0,51	0,46	0,45	0,43	0,42	0,40	
3,00	0,58	0,53	0,47	0,46	0,45	0,44	0,41	
4,00	0,60	0,55	0,49	0,47	0,46	0,45	0,43	
5,00	0,61	0,56	0,49	0,48	0,47	0,46	0,44	

Нечистотија	Фактор на нечистотија, f_1 [54]		
	Период на чистење - години		
	Една	Две	Три
Мала	0,96	0,89	0,86
Нормална	0,83	0,70	0,62
Голема	0,63	0,50	0,43

Број и моќност на флуоресцентни сијалици	Флукс-кодови [54]				
	N_1	N_2	N_3	N_4	N_5
2x40(36) W	0,61	0,89	0,98	0,98	0,50

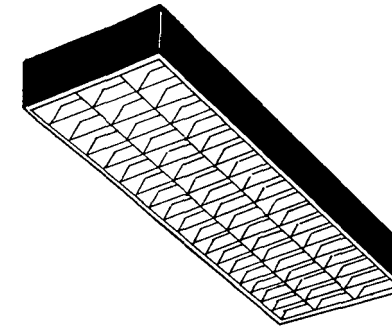

Слика Д.4

Опис: Светилка за надградба со куќиште и бел V-растер, со три флуоресцентни сијалици. Сијалиците можат да бидат со моќност 20(18), (36) или 65(58) W, при што, должината на светилката е 0,646 m, 1,267 m или 1,567 m, соодветно.

Намена: За суви простории со средни или големи светлотехнички барања, каде дополнително се бара ограничување на блескотење.

Индекс на просторија	Коефициент на искористување на осветлението [54]							
	ρ_1	0,8	0,7	0,7	0,5	0,5	0,3	0,0
	ρ_3	0,7	0,5	0,5	0,5	0,3	0,3	0,0
	ρ_4	0,3	0,3	0,1	0,1	0,1	0,1	0,0
0,60	0,38	0,31	0,29	0,29	0,25	0,25	0,22	
0,80	0,44	0,36	0,34	0,34	0,30	0,30	0,27	
1,00	0,49	0,41	0,38	0,38	0,35	0,34	0,31	
1,25	0,53	0,45	0,42	0,41	0,38	0,38	0,35	
1,50	0,56	0,49	0,45	0,44	0,41	0,41	0,38	
2,00	0,60	0,53	0,48	0,47	0,45	0,45	0,42	
2,50	0,62	0,56	0,51	0,50	0,48	0,47	0,44	
3,00	0,64	0,58	0,52	0,51	0,49	0,49	0,46	
4,00	0,66	0,61	0,54	0,53	0,52	0,51	0,48	
5,00	0,67	0,63	0,55	0,54	0,53	0,52	0,50	

Нечистотија	Фактор на нечистотија, f_1 [54]		
	Период на чистење - години		
	Една	Две	Три
Мала	0,96	0,89	0,86
Нормална	0,83	0,70	0,62
Голема	0,63	0,50	0,43

Број и моќност на флуоресцентни сијалици	Флукс-кодови [54]				
	N_1	N_2	N_3	N_4	N_5
3x40(36) W	0,60	0,89	0,98	1,00	0,55

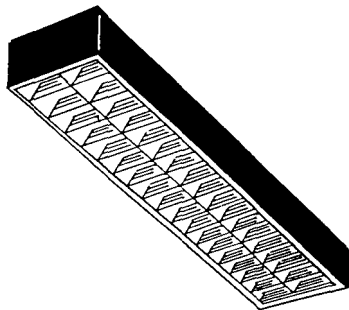

Слика Д.5

Опис: Светилка за надградба со куќиште и огледален V-растер, со две, три или четири флуоресцентни сијалици. Сијалиците можат да бидат со моќност 20(18), 40(36) или 65(58) W, при што должината на светилката е 0,646, 1,267 или 1,567 m, соодветно.

Намена: За суви простории со средни или големи светлотехнички барања, каде дополнително се бара ограничување на блескотење.

Индекс на просторија	Коефициент на искористување на осветлението [54]							
	ρ_1	0,8	0,7	0,7	0,5	0,5	0,3	0,0
	ρ_3	0,7	0,5	0,5	0,5	0,3	0,3	0,0
	ρ_4	0,3	0,3	0,1	0,1	0,1	0,1	0,0
0,60	0,44	0,36	0,34	0,34	0,30	0,30	0,27	
0,80	0,50	0,42	0,40	0,39	0,36	0,35	0,32	
1,00	0,55	0,47	0,44	0,43	0,40	0,40	0,37	
1,25	0,59	0,52	0,48	0,47	0,44	0,44	0,41	
1,50	0,62	0,55	0,50	0,49	0,47	0,46	0,44	
2,00	0,66	0,60	0,54	0,53	0,51	0,50	0,48	
2,50	0,69	0,63	0,56	0,55	0,54	0,53	0,50	
3,00	0,70	0,65	0,58	0,57	0,55	0,54	0,52	
4,00	0,72	0,67	0,59	0,58	0,57	0,56	0,54	
5,00	0,73	0,69	0,60	0,59	0,58	0,57	0,55	

Нечистотија	Фактор на нечистотија, f_1 [54]		
	Период на чистење - години		
	Една	Две	Три
Мала	0,96	0,89	0,86
Нормална	0,83	0,70	0,62
Голема	0,63	0,50	0,43

Број и моќност на флуоресцентни сијалици	Флукс-кодови [54]				
	N_1	N_2	N_3	N_4	N_5
2 или 4x20(18) W	0,67	0,95	0,99	1,00	0,60
2 или 4x40(36) W	0,67	0,95	0,99	1,00	0,60

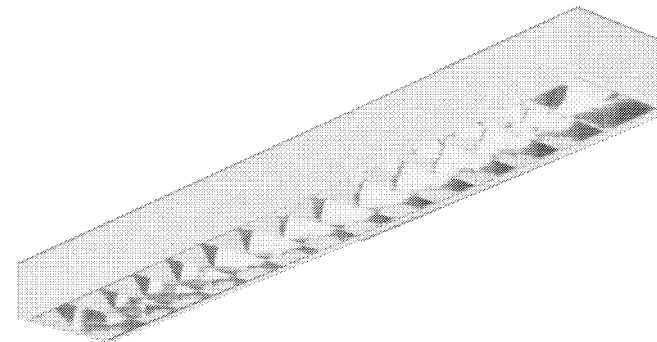

Слика Д.6

Опис: Светилка за надградба со куќиште и параболичен растер, со една или две флуоресцентни сијалици од 18, 36 или 58 W, односно со три флуоресцентни сијалици од 18 или 36 W.

Намена: За суви простории со големи видни барања, во кои се бара зголемена видливост на вертикалните површини и битно намалено блескотење во целиот простор.

Индекс на просторија	Коефициент на искористување на осветлението [60]							
	ρ_1	0,8	0,7	0,7	0,5	0,5	0,3	0,0
	ρ_3	0,7	0,5	0,5	0,5	0,3	0,3	0,0
	ρ_4	0,3	0,3	0,1	0,1	0,1	0,1	0,0
0,60	0,46	0,35	0,34	0,33	0,28	0,28	0,23	
0,80	0,55	0,44	0,42	0,41	0,36	0,36	0,31	
1,00	0,62	0,51	0,48	0,47	0,43	0,42	0,38	
1,25	0,68	0,58	0,53	0,52	0,49	0,48	0,44	
1,50	0,71	0,62	0,57	0,56	0,53	0,52	0,48	
2,00	0,77	0,69	0,62	0,61	0,58	0,57	0,54	
2,50	0,80	0,72	0,65	0,64	0,61	0,60	0,57	
3,00	0,82	0,75	0,67	0,65	0,63	0,62	0,59	
4,00	0,85	0,78	0,69	0,67	0,66	0,65	0,62	
5,00	0,86	0,80	0,70	0,69	0,67	0,66	0,63	

Нечистотија	Фактор на нечистотија, f_1 [54]		
	Период на чистење - години		
	Една	Две	Три
Мала	0,96	0,89	0,86
Нормална	0,83	0,70	0,62
Голема	0,63	0,50	0,43

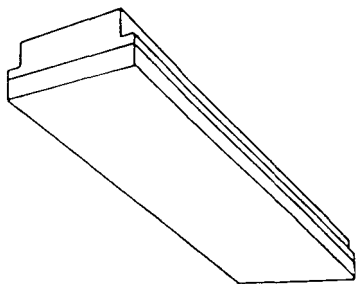

Слика Д.7

Опис: Светилка за вградување со ниска опална капа, со две флуоресцентни сијалици од 20(18), 40(36) или 65(58) W, за касетирани плафони со модули 312 и 625 mm.

Намена: За суви простории со мали или средни светлотехнички барања.

Индекс на просторија	Коефициент на искористување на осветлението [53]							
	ρ_1	0,8	0,7	0,7	0,5	0,5	0,3	0,0
	ρ_3	0,7	0,5	0,5	0,5	0,3	0,3	0,0
	ρ_4	0,3	0,3	0,1	0,1	0,1	0,1	0,0
0,60	0,27	0,20	0,19	0,18	0,15	0,15	0,12	
0,80	0,31	0,24	0,23	0,22	0,19	0,19	0,16	
1,00	0,35	0,28	0,26	0,25	0,22	0,22	0,19	
1,25	0,38	0,31	0,29	0,28	0,25	0,25	0,22	
1,50	0,41	0,34	0,31	0,30	0,28	0,27	0,24	
2,00	0,44	0,38	0,35	0,33	0,31	0,30	0,28	
2,50	0,46	0,41	0,37	0,35	0,34	0,33	0,30	
3,00	0,48	0,43	0,38	0,37	0,35	0,34	0,32	
4,00	0,50	0,45	0,40	0,39	0,37	0,36	0,34	
5,00	0,51	0,47	0,41	0,40	0,38	0,37	0,35	

Нечистотија	Фактор на нечистотија, f_1 [53]		
	Период на чистење - години		
	Една	Две	Три
Мала	0,93	0,88	0,86
Нормална	0,83	0,77	0,72
Голема	0,72	0,64	0,59

Број и моќност на флуоресцентни сијалици	Флукс-кодови [53]				
	N_1	N_2	N_3	N_4	N_5
2x40(36) W	0,45	0,77	0,95	0,95	0,43

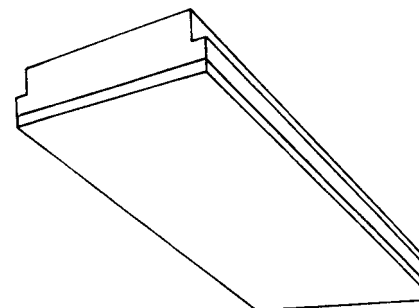

Слика Д.8

Опис: Светилка за вградување со ниска опална капа, со три флуоресцентни сијалици од 20(18), 40(36) или 65(58) W, за касетирани плафони со модули 312 и 625 mm.

Намена: За суви простории со мали или средни светлотехнички барања.

Индекс на просторија	Коефициент на искористување на осветлението [53]							
	ρ_1	0,8	0,7	0,7	0,5	0,5	0,3	0,0
	ρ_3	0,7	0,5	0,5	0,5	0,3	0,3	0,0
	ρ_4	0,3	0,3	0,1	0,1	0,1	0,1	0,0
0,60	0,31	0,23	0,22	0,21	0,18	0,17	0,13	
0,80	0,37	0,28	0,27	0,25	0,22	0,21	0,17	
1,00	0,41	0,32	0,30	0,29	0,25	0,25	0,21	
1,25	0,45	0,36	0,34	0,32	0,29	0,28	0,24	
1,50	0,48	0,40	0,36	0,35	0,32	0,31	0,27	
2,00	0,52	0,45	0,40	0,39	0,36	0,35	0,31	
2,50	0,55	0,48	0,43	0,41	0,39	0,37	0,33	
3,00	0,56	0,50	0,45	0,43	0,41	0,39	0,35	
4,00	0,59	0,53	0,47	0,45	0,43	0,41	0,38	
5,00	0,60	0,55	0,48	0,46	0,44	0,43	0,39	

Нечистотија	Фактор на нечистотија, f_1 [53]		
	Период на чистење - години		
	Една	Две	Три
Мала	0,93	0,88	0,86
Нормална	0,83	0,77	0,72
Голема	0,72	0,64	0,59

Број и моќност на флуоресцентни сијалици	Флукс-кодови [53]				
	N_1	N_2	N_3	N_4	N_5
3x40(36) W	0,44	0,75	0,93	0,91	0,52

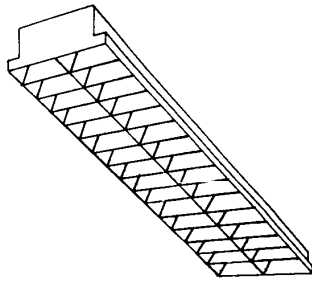

Слика Д.9

Опис: Светилка за вградување со бел V-растер, со две флуоресцентни сијалици од 20(18), 40(36) или 65(58) W, за касетирани плафони со модули од 312 и 625 mm.

Намена: За суви простории со средни и големи светлотехнички барања, каде дополнително се бара ограничување на блескотењето.

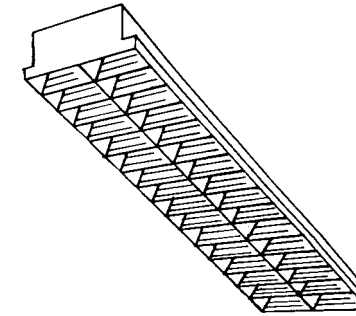

Слика Д.10

Опис: Светилка за вградување со огледален V-растер, со две флуоресцентни сијалици од 20(18), 40(36) или 65(58) W, за касетирани плафони со модули од 312 и 625 mm.

Намена: За суви простории со големи светлотехнички барања, каде дополнително се бара ограничување на блескотењето.

Индекс на просторија	Коефициент на искористување на осветлението [53]							
	ρ_1	0,8	0,7	0,7	0,5	0,5	0,3	0,0
	ρ_3	0,7	0,5	0,5	0,5	0,3	0,3	0,0
	ρ_4	0,3	0,3	0,1	0,1	0,1	0,1	0,0
0,60	0,30	0,25	0,23	0,23	0,21	0,21	0,18	
0,80	0,35	0,29	0,27	0,27	0,24	0,24	0,22	
1,00	0,38	0,32	0,30	0,30	0,27	0,27	0,25	
1,25	0,41	0,35	0,33	0,32	0,30	0,30	0,28	
1,50	0,43	0,38	0,35	0,34	0,32	0,32	0,30	
2,00	0,46	0,41	0,37	0,37	0,35	0,35	0,33	
2,50	0,48	0,43	0,39	0,38	0,37	0,37	0,35	
3,00	0,49	0,45	0,40	0,39	0,38	0,38	0,36	
4,00	0,51	0,47	0,41	0,40	0,40	0,39	0,37	
5,00	0,51	0,48	0,42	0,41	0,40	0,40	0,38	

Индекс на просторија	Коефициент на искористување на осветлението[53]							
	ρ_1	0,8	0,7	0,7	0,5	0,5	0,3	0,0
	ρ_3	0,7	0,5	0,5	0,5	0,3	0,3	0,0
	ρ_4	0,3	0,3	0,1	0,1	0,1	0,1	0,0
0,60	0,38	0,32	0,30	0,30	0,27	0,27	0,24	
0,80	0,44	0,37	0,35	0,34	0,32	0,31	0,29	
1,00	0,48	0,41	0,39	0,38	0,35	0,35	0,32	
1,25	0,51	0,45	0,42	0,41	0,39	0,38	0,36	
1,50	0,54	0,48	0,44	0,43	0,41	0,41	0,38	
2,00	0,58	0,52	0,47	0,46	0,45	0,44	0,42	
2,50	0,60	0,55	0,49	0,48	0,47	0,46	0,44	
3,00	0,61	0,56	0,50	0,49	0,48	0,47	0,45	
4,00	0,63	0,58	0,52	0,51	0,50	0,49	0,47	
5,00	0,64	0,60	0,52	0,51	0,51	0,50	0,48	

Нечистотија	Фактор на нечистотија, f_1 [53]		
	Период на чистење - години		
	Една	Две	Три
Мала	0,96	0,89	0,86
Нормална	0,83	0,70	0,62
Голема	0,63	0,50	0,43

Нечистотија	Фактор на нечистотија, f_1 [53]		
	Период на чистење - години		
	Една	Две	Три
Мала	0,96	0,89	0,86
Нормална	0,83	0,70	0,62
Голема	0,63	0,50	0,43

Број и моќност на флуоресцентни сијалици	Флукс-кодови [53]				
	N_1	N_2	N_3	N_4	N_5
2x40(36) W	0,65	0,91	0,98	1,00	0,42

Број и моќност на флуоресцентни сијалици	Флукс-кодови [53]				
	N_1	N_2	N_3	N_4	N_5
2x40(36) W	0,69	0,94	0,99	1,00	0,52

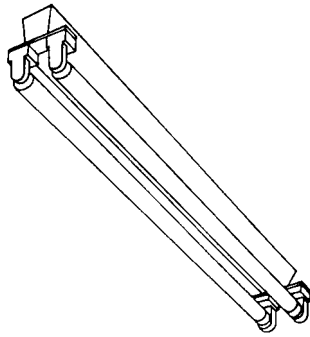

Слика Д.11

ОПИС: Светилка за поставување во низи со две флуоресцентни сијалици. Сијалиците можат да бидат со моќност 20(18), 40(36) или 65(58) W при што должината на светилката е 0,618 m, 1,228 m или 1,528 m, соодветно.

Намена: За ниски и средно високи суви простории.

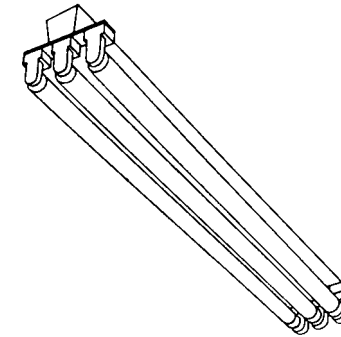

Слика Д.12

ОПИС: Светилка за поставување во низи со три флуоресцентни сијалици. Сијалиците можат да бидат со моќност 20(18), 40(36) или 65(58) W при што должината на светилката е 0,618 m, 1,228 m или 1,528 m, соодветно.

Намена: За ниски и средно високи суви простории.

Индекс на просторија	Коефициент на искористување на осветлението [55]							
	ρ_1	0,8	0,7	0,7	0,5	0,5	0,3	0,0
	ρ_3	0,7	0,5	0,5	0,5	0,3	0,3	0,0
	ρ_4	0,3	0,3	0,1	0,1	0,1	0,1	0,0
0,60	0,51	0,35	0,34	0,29	0,24	0,21	0,13	
0,80	0,61	0,43	0,41	0,36	0,30	0,26	0,17	
1,00	0,68	0,50	0,47	0,41	0,35	0,31	0,21	
1,25	0,75	0,57	0,53	0,46	0,41	0,35	0,24	
1,50	0,80	0,62	0,57	0,50	0,45	0,39	0,27	
2,00	0,87	0,70	0,64	0,56	0,51	0,45	0,32	
2,50	0,92	0,76	0,68	0,60	0,55	0,49	0,36	
3,00	0,95	0,80	0,71	0,62	0,58	0,51	0,38	
4,00	0,99	0,84	0,74	0,65	0,62	0,54	0,41	
5,00	0,99	0,87	0,76	0,67	0,64	0,56	0,42	

Индекс на просторија	Коефициент на искористување на осветлението [55]							
	ρ_1	0,8	0,7	0,7	0,5	0,5	0,3	0,0
	ρ_3	0,7	0,5	0,5	0,5	0,3	0,3	0,0
	ρ_4	0,3	0,3	0,1	0,1	0,1	0,1	0,0
0,60	0,50	0,35	0,33	0,29	0,24	0,21	0,13	
0,80	0,59	0,43	0,40	0,35	0,30	0,26	0,17	
1,00	0,66	0,49	0,46	0,41	0,35	0,31	0,21	
1,25	0,73	0,56	0,52	0,46	0,40	0,35	0,25	
1,50	0,78	0,61	0,56	0,49	0,45	0,39	0,28	
2,00	0,85	0,69	0,63	0,55	0,51	0,44	0,33	
2,50	0,90	0,74	0,67	0,59	0,55	0,48	0,36	
3,00	0,93	0,78	0,70	0,61	0,58	0,51	0,38	
4,00	0,97	0,83	0,73	0,64	0,61	0,53	0,40	
5,00	0,99	0,85	0,75	0,66	0,63	0,55	0,42	

Нечистотија	Фактор на нечистотија, f_1 [55]		
	Период на чистење - години		
	Една	Две	Три
Мала	0,97	0,94	0,93
Нормална	0,89	0,85	0,80
Голема	0,72	0,61	0,55

Нечистотија	Фактор на нечистотија, f_1 [55]		
	Период на чистење - години		
	Една	Две	Три
Мала	0,97	0,94	0,93
Нормална	0,89	0,85	0,80
Голема	0,72	0,61	0,55

Број и моќност на флуоресцентни сијалици	Флукс-кодови [55]				
	N_1	N_2	N_3	N_4	N_5
2x40(36) W	0,34	0,62	0,85	0,60	0,96

Број и моќност на флуоресцентни сијалици	Флукс-кодови [55]				
	N_1	N_2	N_3	N_4	N_5
3x40(36) W	0,35	0,65	0,88	0,60	0,94

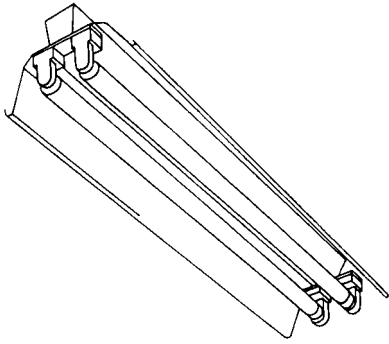

Слика Д.13

Опис: Светилка за поставување во низи, со рефлектор, со две флуоресцентни сијалици. Сијалиците можат да бидат со моќност 20(18), 40(36) или 65(58) W при што должината на светилката е 0,618 m, 1,228 m или 1,528 m, соодветно.

Намена: За ниски и средно високи суви простории.

Индекс на просторија	Коефициент на искористување на осветлението [55]							
	ρ_1	ρ_2	ρ_3	ρ_4	ρ_5	ρ_6	ρ_7	ρ_8
0,60	0,8	0,7	0,7	0,5	0,5	0,3	0,0	
0,80	0,7	0,5	0,5	0,5	0,3	0,3	0,0	
1,00	0,3	0,3	0,1	0,1	0,1	0,1	0,0	
0,60	0,50	0,37	0,35	0,34	0,29	0,28	0,23	
0,80	0,59	0,46	0,43	0,42	0,36	0,36	0,30	
1,00	0,66	0,53	0,49	0,48	0,42	0,42	0,36	
1,25	0,72	0,60	0,55	0,54	0,48	0,48	0,42	
1,50	0,77	0,65	0,60	0,58	0,53	0,52	0,47	
2,00	0,84	0,73	0,66	0,64	0,60	0,59	0,54	
2,50	0,89	0,78	0,70	0,68	0,65	0,64	0,59	
3,00	0,92	0,82	0,73	0,71	0,68	0,67	0,63	
4,00	0,96	0,87	0,77	0,75	0,72	0,71	0,67	
5,00	0,98	0,90	0,79	0,77	0,75	0,74	0,70	

Нечистотија	Фактор на нечистотија, f_1 [55]		
	Период на чистење - години		
	Една	Две	Три
Мала	0,96	0,89	0,86
Нормална	0,83	0,70	0,62
Голема	0,63	0,50	0,43

Број и моќност на флуоресцентни сијалици	Флукс-кодови [55]				
	N_1	N_2	N_3	N_4	N_5
2x40(36) W	0,44	0,76	0,95	1,00	0,82

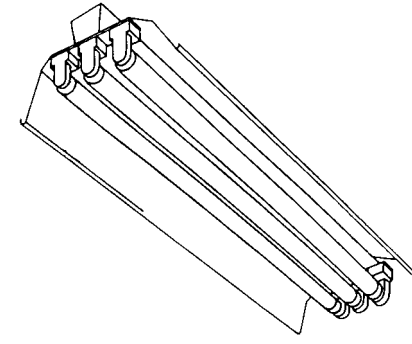

Слика Д.14

Опис: Светилка за поставување во низи, со рефлектор, со три флуоресцентни сијалици. Сијалиците можат да бидат со моќност 20(18), 40(36) или 65(58) W при што должината на светилката е 0,618 m, 1,228 m или 1,528 m, соодветно.

Намена: За ниски и средно високи суви простории.

Индекс на просторија	Коефициент на искористување на осветлението [55]							
	ρ_1	ρ_2	ρ_3	ρ_4	ρ_5	ρ_6	ρ_7	ρ_8
0,60	0,8	0,7	0,7	0,5	0,5	0,3	0,0	
0,80	0,7	0,5	0,5	0,5	0,3	0,3	0,0	
1,00	0,3	0,3	0,1	0,1	0,1	0,1	0,0	
0,60	0,49	0,37	0,35	0,34	0,28	0,28	0,23	
0,80	0,58	0,45	0,43	0,41	0,36	0,35	0,29	
1,00	0,65	0,52	0,49	0,47	0,42	0,41	0,35	
1,25	0,72	0,59	0,54	0,53	0,48	0,47	0,41	
1,50	0,76	0,64	0,59	0,57	0,52	0,52	0,46	
2,00	0,83	0,72	0,65	0,64	0,60	0,58	0,53	
2,50	0,88	0,77	0,69	0,68	0,64	0,63	0,58	
3,00	0,91	0,81	0,72	0,71	0,67	0,66	0,62	
4,00	0,95	0,86	0,76	0,74	0,72	0,70	0,66	
5,00	0,97	0,89	0,78	0,76	0,74	0,73	0,69	

Нечистотија	Фактор на нечистотија, f_1 [55]		
	Период на чистење - години		
	Една	Две	Три
Мала	0,96	0,89	0,86
Нормална	0,83	0,70	0,62
Голема	0,63	0,50	0,43

Број и моќност на флуоресцентни сијалици	Флукс-кодови [55]				
	N_1	N_2	N_3	N_4	N_5
3x40(36) W	0,43	0,76	0,95	1,00	0,81

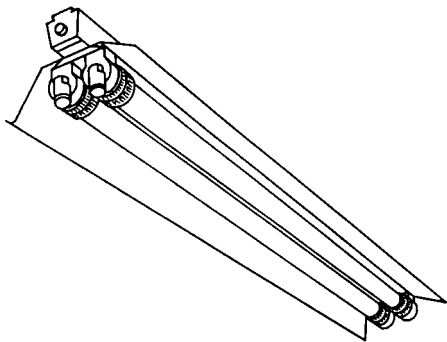

Слика Д.15

ОПИС: Светилка отпорна на влага и прав, со рефлектортор, со две флуоресцентни сијалици, секоја со моќност 40(36)W. Должината на светилката е 1,36 m.

Намена: За влажни и/или простории со прав во занаетството, индустријата, живинарството, гаражите и слично, како и за покриени надворешни простори.

Индекс на просторија	Коефициент на искористување на осветлението [55]							
	ρ_1	0,8	0,7	0,7	0,5	0,5	0,3	0,0
	ρ_3	0,7	0,5	0,5	0,5	0,3	0,3	0,0
	ρ_4	0,3	0,3	0,1	0,1	0,1	0,1	0,0
0,60	0,45	0,33	0,32	0,31	0,26	0,26	0,21	
0,80	0,53	0,41	0,39	0,38	0,32	0,32	0,27	
1,00	0,59	0,47	0,44	0,43	0,38	0,37	0,32	
1,25	0,65	0,53	0,49	0,48	0,43	0,43	0,37	
1,50	0,69	0,58	0,53	0,52	0,48	0,47	0,42	
2,00	0,76	0,66	0,59	0,58	0,54	0,53	0,48	
2,50	0,80	0,70	0,63	0,62	0,58	0,57	0,53	
3,00	0,82	0,74	0,66	0,64	0,61	0,60	0,56	
4,00	0,86	0,78	0,69	0,68	0,65	0,64	0,60	
5,00	0,88	0,81	0,71	0,70	0,68	0,66	0,63	

Нечистотија	Фактор на нечистотија, f_1 [55]		
	Период на чистење - години		
	Една	Две	Три
Мала	0,96	0,89	0,86
Нормална	0,83	0,70	0,62
Голема	0,63	0,50	0,43

Број и моќност на флуоресцентни сијалици	Флукс-кодови [55]				
	N_1	N_2	N_3	N_4	N_5
2x40(36) W	0,34	0,63	0,86	0,59	0,85

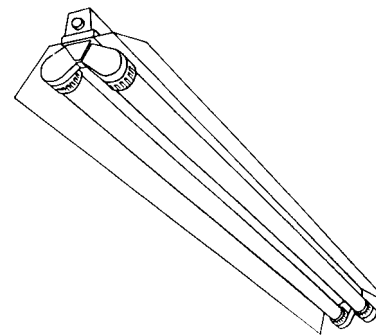

Слика Д.16

ОПИС: Светилка за простории и покриени надворешни простори со влажна и агресивна атмосфера, со рефлектор и две флуоресцентни сијалици од 40(36) W. Должината на светилката е 1,26 m.

Намена: За атмосфера со најмногу 5%: H_2SO_4 , NH_4 , HCl и оцетна киселина; до 30% алкохол; до 2% натриумова база; сапун; нафта; CO и CO_2 ; NaCl; детергент; морска вода; етер; сулфурводород; глицерин; глизантин; бензин.

Индекс на просторија	Коефициент на искористување на осветлението [55]							
	ρ_1	0,8	0,7	0,7	0,5	0,5	0,3	0,0
	ρ_3	0,7	0,5	0,5	0,5	0,3	0,3	0,0
	ρ_4	0,3	0,3	0,1	0,1	0,1	0,1	0,0
0,60	0,53	0,38	0,36	0,34	0,28	0,26	0,19	
0,80	0,62	0,46	0,44	0,41	0,34	0,32	0,24	
1,00	0,70	0,53	0,50	0,46	0,40	0,38	0,29	
1,25	0,76	0,60	0,56	0,52	0,46	0,43	0,34	
1,50	0,81	0,66	0,60	0,56	0,51	0,47	0,38	
2,00	0,89	0,74	0,67	0,62	0,58	0,54	0,45	
2,50	0,94	0,80	0,72	0,66	0,62	0,58	0,49	
3,00	0,97	0,84	0,75	0,69	0,65	0,61	0,52	
4,00	0,99	0,89	0,78	0,73	0,69	0,65	0,55	
5,00	0,99	0,92	0,80	0,75	0,72	0,67	0,57	

Нечистотија	Фактор на нечистотија, f_1 [55]		
	Период на чистење - години		
	Една	Две	Три
Мала	0,96	0,89	0,86
Нормална	0,83	0,70	0,62
Голема	0,63	0,50	0,43

Број и моќност на флуоресцентни сијалици	Флукс-кодови [55]				
	N_1	N_2	N_3	N_4	N_5
2x40(36) W	0,39	0,68	0,89	0,79	0,93

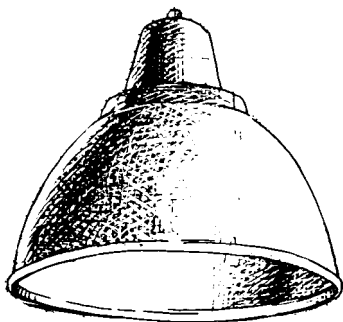

Слика Д.17

Опис: Индустриска светилка со кукиште и дифузен рефлектор од алуминиум, за една живина сијалица со висок притисок и моќност 400 W.

Намена: За ниски и средно високи суви простории во индустријата и занаетството.

Индекс		Коефициент на искористување на осветлението [56]						
на просторија	ρ_1	0,8	0,7	0,7	0,5	0,5	0,3	0,0
	ρ_3	0,7	0,5	0,5	0,5	0,3	0,3	0,0
	ρ_4	0,3	0,3	0,1	0,1	0,1	0,1	0,0
0,60		0,53	0,39	0,38	0,37	0,30	0,30	0,24
0,80		0,63	0,48	0,46	0,44	0,38	0,38	0,32
1,00		0,70	0,56	0,52	0,51	0,45	0,44	0,38
1,25		0,77	0,63	0,59	0,57	0,51	0,51	0,44
1,50		0,82	0,69	0,63	0,62	0,56	0,55	0,50
2,00		0,90	0,78	0,70	0,68	0,64	0,63	0,58
2,50		0,94	0,83	0,75	0,73	0,69	0,68	0,63
3,00		0,98	0,88	0,78	0,76	0,73	0,71	0,67
4,00		0,99	0,93	0,82	0,80	0,77	0,76	0,72
5,00		0,99	0,96	0,84	0,82	0,80	0,79	0,75

Нечистотија	Фактор на нечистотија, f_1 [56]		
	Период на чистење - години		
	Една	Две	Три
Мала	0,96	0,89	0,86
Нормална	0,83	0,70	0,62
Голема	0,63	0,50	0,43

Број и моќност на живини сијалици со висок притисок	Флуks-кодови [56]				
	N_1	N_2	N_3	N_4	N_5
1x400 W	0,43	0,76	0,96	1,00	0,87

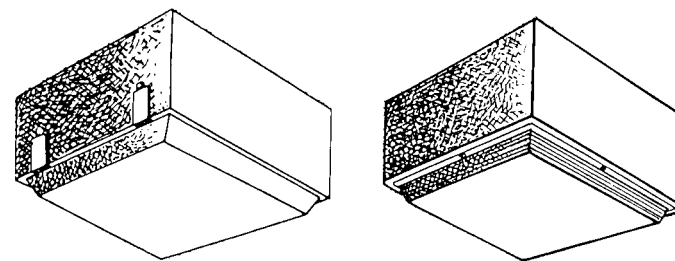

Слика Д.18

Опис: Индустриска светилка со кукиште и рефлектор од елоксиран алуминиум, со капа од призматичен поликарбонат (некршлив), за една живина сијалица со висок притисок и моќност 125 W.

Намена: За средно високи и високи простории со влажна атмосфера.

Индекс на просторија	Коефициент на искористување на осветлението [56]							
	ρ_1	0,8	0,7	0,7	0,5	0,5	0,3	0,0
	ρ_3	0,7	0,5	0,5	0,5	0,3	0,3	0,0
	ρ_4	0,3	0,3	0,1	0,1	0,1	0,1	0,0
0,60		0,54	0,42	0,41	0,40	0,35	0,35	0,30
0,80		0,63	0,51	0,48	0,47	0,43	0,42	0,37
1,00		0,70	0,58	0,54	0,53	0,49	0,48	0,43
1,25		0,76	0,65	0,60	0,59	0,55	0,54	0,49
1,50		0,80	0,70	0,64	0,62	0,59	0,58	0,54
2,00		0,86	0,77	0,69	0,68	0,65	0,64	0,60
2,50		0,90	0,81	0,73	0,71	0,69	0,68	0,64
3,00		0,92	0,84	0,75	0,73	0,71	0,70	0,67
4,00		0,95	0,88	0,78	0,76	0,74	0,73	0,70
5,00		0,97	0,90	0,79	0,78	0,76	0,75	0,72

Нечистотија	Фактор на нечистотија, f_1 [56]		
	Период на чистење - години		
	Една	Две	Три
Мала	0,93	0,88	0,86
Нормална	0,83	0,77	0,72
Голема	0,72	0,64	0,59

Број и моќност на живини сијалици со висок притисок	Флуks-кодови [56]				
	N_1	N_2	N_3	N_4	N_5
1x125 W	0,58	0,89	0,99	1,00	0,79

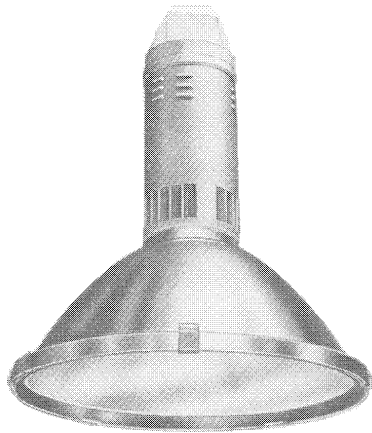

Слика Д.19

Опис: Индустриска светилка со широк сноп, отворена, за една живина сијалица со висок притисок и моќност 400 W или за една натриумова сијалица со висок притисок и моќност 400 W.

Намена: За индустриски хали, спортски хали и друго.

Индекс		Коефициент на искористување на осветлението [63]						
на просторија	ρ_1	0,8	0,7	0,7	0,5	0,5	0,3	0,0
	ρ_3	0,7	0,5	0,5	0,5	0,3	0,3	0,0
	ρ_4	0,3	0,3	0,1	0,1	0,1	0,1	0,0
0,60		0,55	0,52	0,55	0,52	0,50	0,52	0,50
1,00		0,67	0,64	0,67	0,64	0,62	0,63	0,62
1,50		0,74	0,71	0,74	0,71	0,67	0,70	0,67
2,00		0,77	0,75	0,77	0,74	0,73	0,74	0,73
2,50		0,90	0,77	0,78	0,77	0,75	0,76	0,75
3,00		0,92	0,79	0,79	0,78	0,77	0,77	0,76
4,00		0,95	0,80	0,80	0,79	0,79	0,79	0,78
5,00		0,97	0,82	0,82	0,80	0,79	0,80	0,79

Нечистотија	Фактор на нечистотија, f_1 [63]		
	Период на чистење - години		
	Една	Две	Три
Мала	0,94	0,90	0,86
Нормална	0,83	0,70	0,63
Голема	0,63	0,50	0,44

Коефициенти на стареење (LLMF) и преживување (LSF) за светлинските извори

ФС (мулти- и трифосфор)

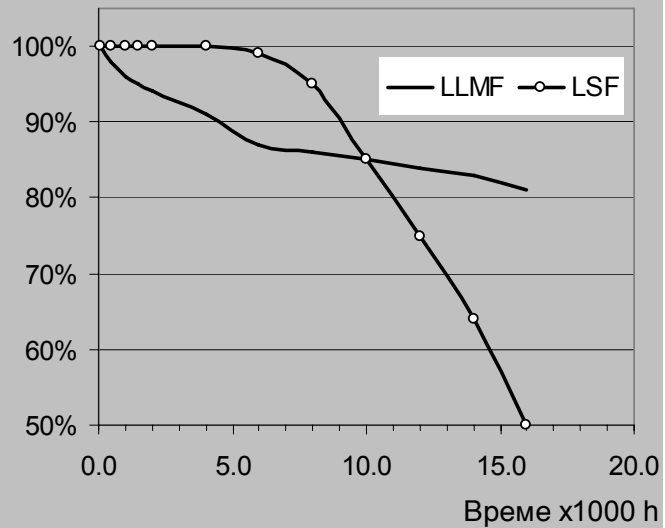

ФС (халофосфати)

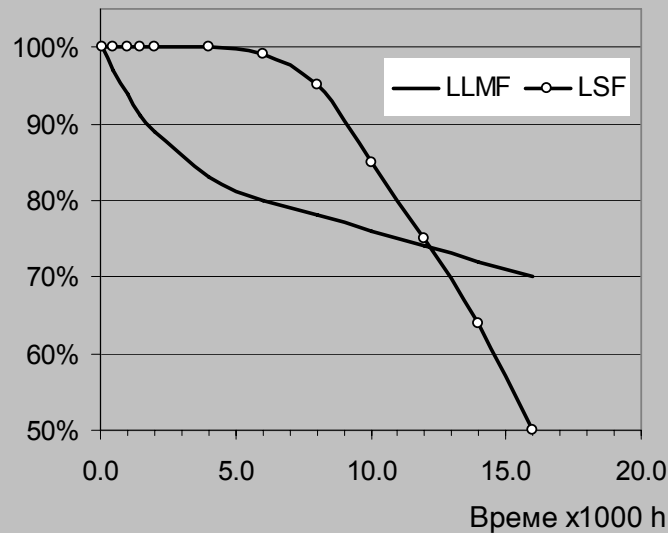

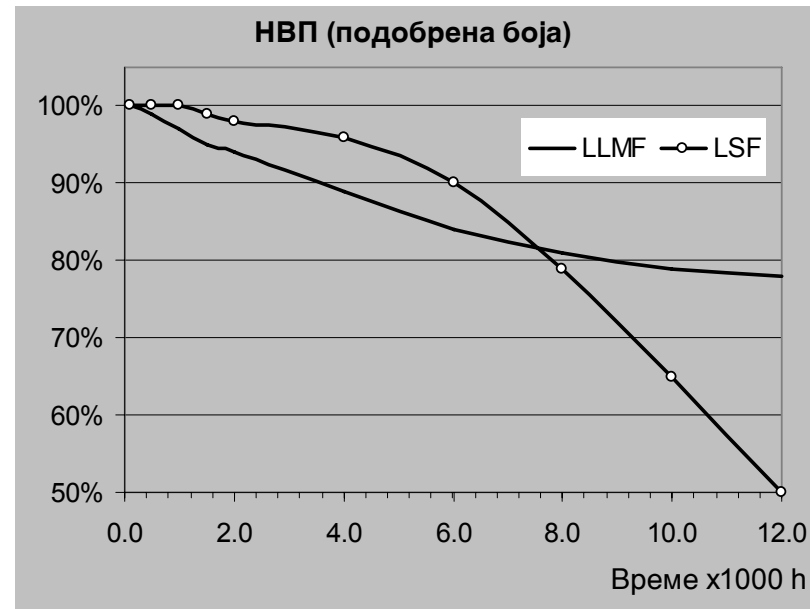
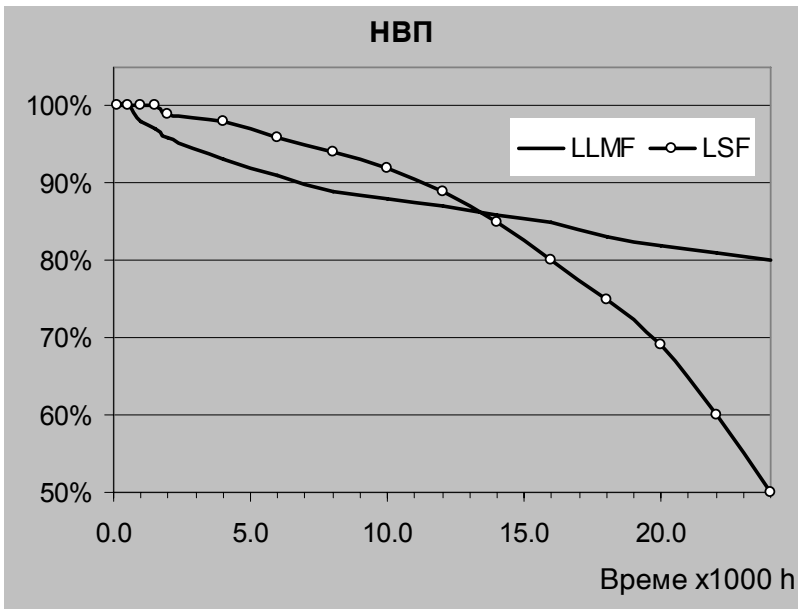
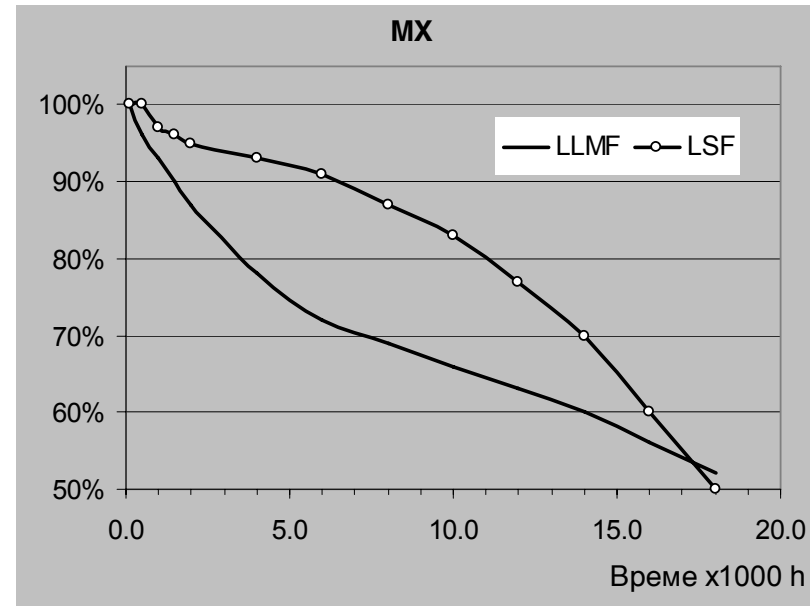
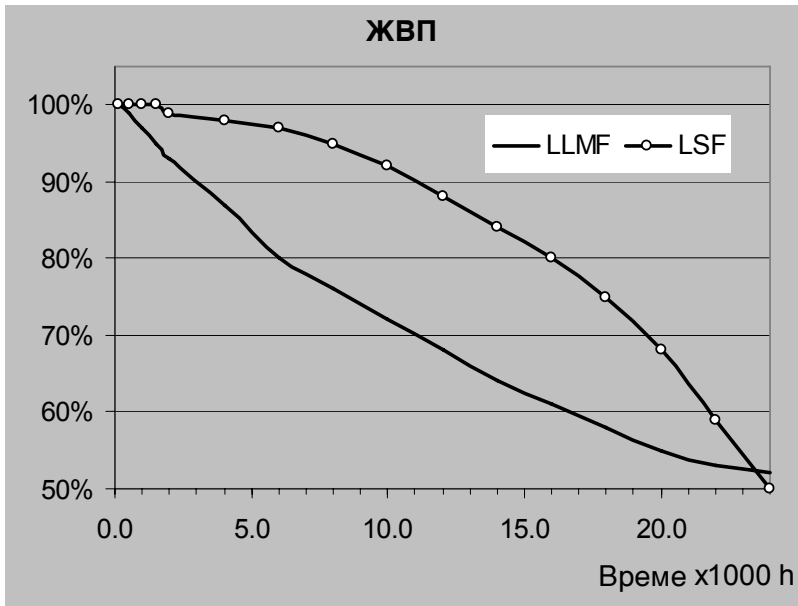

Коефициент на нечистотија на светилките

